

# A2013 PA CONNECTOR

2.00mm Pitch/Disconnectable Crimp style connectors

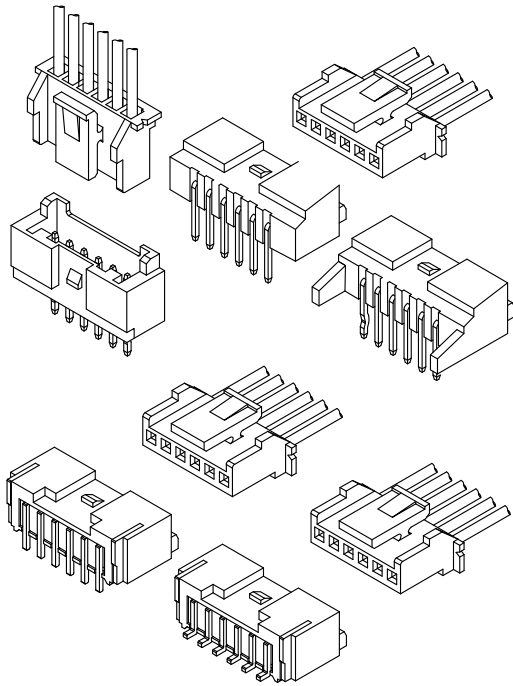

**PA** E529482

- Secure locking structure
- Low insertion force
- Suction area for picking up
- Improvement of engagement with prying

## Specifications:

- Current rating: 3.0 A / AC,DC (AWG #22)
- Voltage rating: 250 V AC/DC
- Temperature range: -25°C ~ +105°C  
(including temperature rise in applying electrical current)
- Contact resistance: Initial value/ 30mΩ max  
Insulation resistance: 1000 MΩ min  
Withstanding voltage: 1000 VAC/minute  
Applicable wire: Conductor size/ AWG#28~#22  
Insulation O.D./ 0.80 to 1.50 mm
- \* Compliant with RoHS2/ HF/ REACH
- \* Refer to "General Instruction and Notice when using Terminals and Connectors"
- \* Contact CSG for details

## Material:

Housing: PA66 UL94-V0;Color:White  
Terminal: Phosphor/ Tin-plated  
DIP Wafer Housing: PA66,UL94-V0;Color:White  
DIP Wafer Pin: Bass/ Tin-plated  
SMT Wafer Housing: PA6T,UL94-V0;Color:Natural  
SMT Wafer Pin: Bass/ Tin-plated  
SMT Wafer Fixed Foot; Bass/ Tin-plated

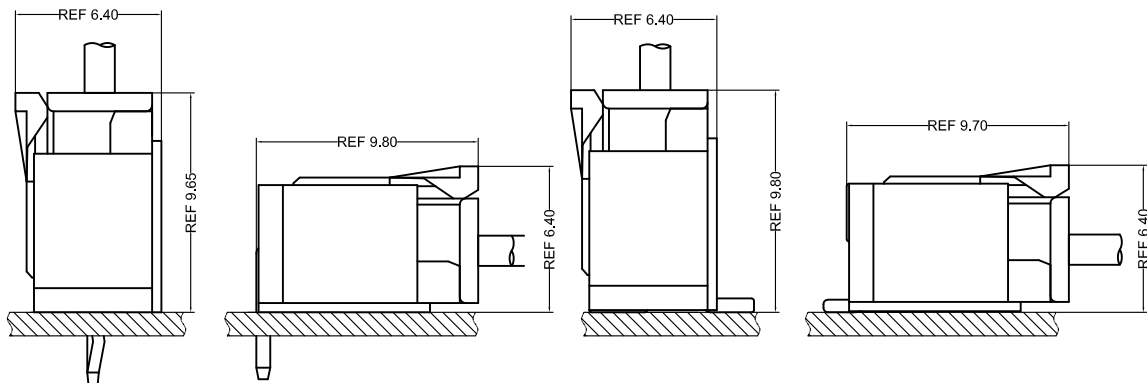

- Note: 1. The above figure is the figure viewed from the connector mounting side.  
2. Tolerances are non-cumulative:  $\pm 0.08$  mm for all centers.  
3. The dimensions above should serve as a guideline. Contact CSG for details.

**CSG**

Tel: +86-769-85312070 85375507 E-mail: James@cs-g-china.com www.cs-g-china.com www.jst-connector.cn

# A2013 PA

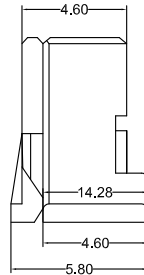
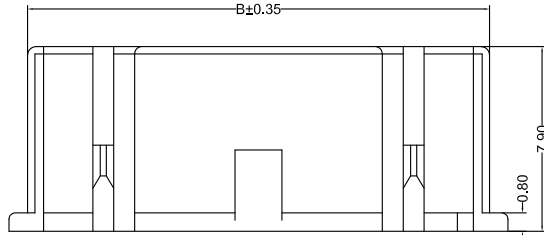
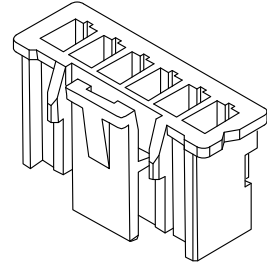
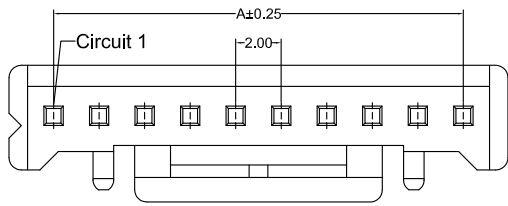

A2013HF 0XX AK P6 9 005  
 PIN  
 005=5PINS  
 SPECIAL  
 AK=BUCKLE  
 Material  
 P6=PA66 94V-0  
 Code  
 005  
 Color  
 9=White

CSG PART NO.	Dimension mm		Qty/BAG
	A	B	
A2013HF002AKP69005	2.00	4.30	1000PCS
A2013HF003AKP69005	4.00	6.30	1000PCS
A2013HF004AKP69005	6.00	8.30	1000PCS
A2013HF005AKP69005	8.00	10.30	1000PCS
A2013HF006AKP69005	10.00	12.30	1000PCS
A2013HF007AKP69005	12.00	14.30	1000PCS
A2013HF008AKP69005	14.00	16.30	1000PCS
A2013HF009AKP69005	16.00	18.30	1000PCS
A2013HF010AKP69005	18.00	20.30	1000PCS
A2013HF011AKP69005	20.00	22.30	1000PCS
A2013HF012AKP69005	22.00	24.30	1000PCS
A2013HF013AKP69005	24.00	26.30	1000PCS
A2013HF014AKP69005	26.00	28.30	1000PCS
A2013HF015AKP69005	28.00	30.30	1000PCS

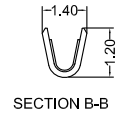
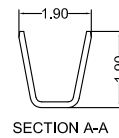
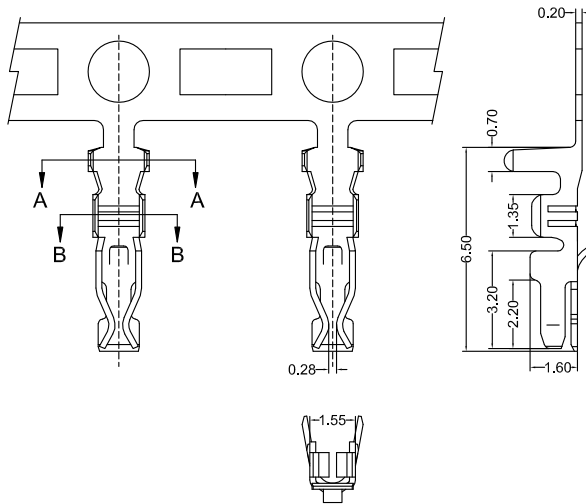

A2004 M 0 A TP 002  
 Type  
 M=Female Terminal  
 SPECIAL  
 O=NO Special  
 Material  
 A=Phosphor  
 Finish  
 TP=Tin-Plated  
 Code  
 002

CSG PART NO.	Wire Range	Insulation O.D.	Qty/Reel
A2004M0ATP002	AWG#22-#28	1.50mm(max)	12000PCS



# A2013 PA

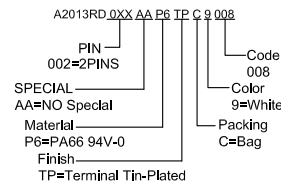
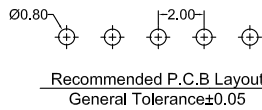
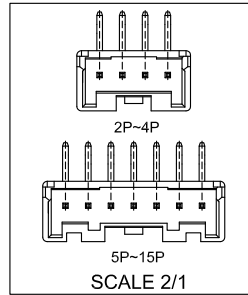
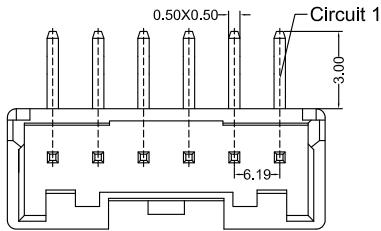
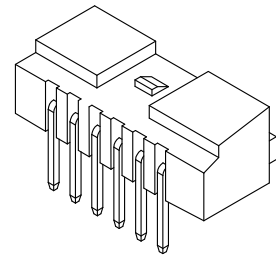
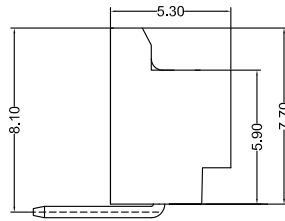
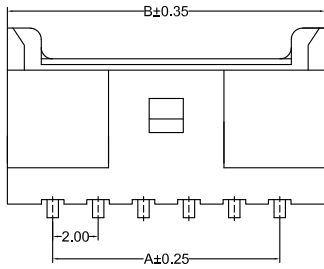

CSG PART NO.	Dimension mm		Q'ty/BAG
	A	B	
A2013RD002AAP6TPC9008	2.00	6.00	1000PCS
A2013RD003AAP6TPC9008	4.00	8.00	1000PCS
A2013RD004AAP6TPC9008	6.00	10.00	1000PCS
A2013RD005AAP6TPC9008	8.00	12.00	1000PCS
A2013RD006AAP6TPC9008	10.00	14.00	1000PCS
A2013RD007AAP6TPC9008	12.00	16.00	1000PCS
A2013RD008AAP6TPC9008	14.00	18.00	1000PCS
A2013RD009AAP6TPC9008	16.00	20.00	1000PCS
A2013RD010AAP6TPC9008	18.00	22.00	1000PCS
A2013RD011AAP6TPC9008	20.00	24.00	1000PCS
A2013RD012AAP6TPC9008	22.00	26.00	1000PCS
A2013RD013AAP6TPC9008	24.00	28.00	1000PCS
A2013RD014AAP6TPC9008	26.00	30.00	1000PCS
A2013RD015AAP6TPC9008	28.00	32.00	1000PCS

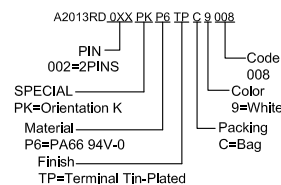
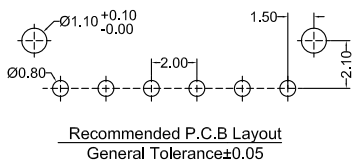
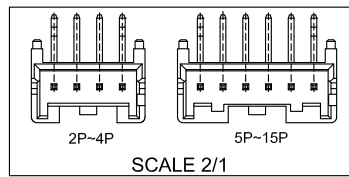
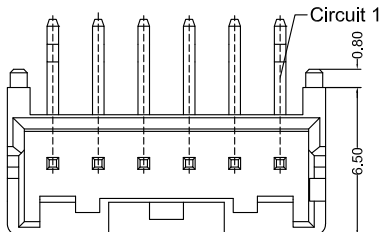
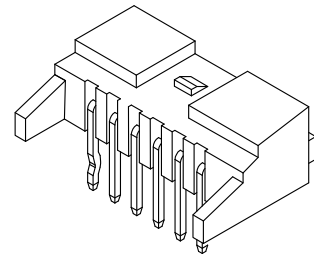
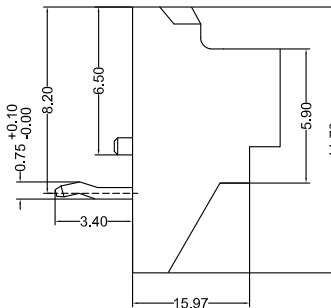
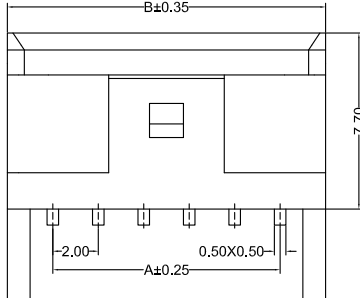

CSG PART NO.	Dimension mm		Q'ty/BAG
	A	B	
A2013RD002PKP6TPC9008	2.00	6.00	1000PCS
A2013RD003PKP6TPC9008	4.00	8.00	1000PCS
A2013RD004PKP6TPC9008	6.00	10.00	1000PCS
A2013RD005PKP6TPC9008	8.00	12.00	1000PCS
A2013RD006PKP6TPC9008	10.00	14.00	1000PCS
A2013RD007PKP6TPC9008	12.00	16.00	1000PCS
A2013RD008PKP6TPC9008	14.00	18.00	1000PCS
A2013RD009PKP6TPC9008	16.00	20.00	1000PCS
A2013RD010PKP6TPC9008	18.00	22.00	1000PCS
A2013RD011PKP6TPC9008	20.00	24.00	1000PCS
A2013RD012PKP6TPC9008	22.00	26.00	1000PCS
A2013RD013PKP6TPC9008	24.00	28.00	1000PCS
A2013RD014PKP6TPC9008	26.00	30.00	1000PCS
A2013RD015AAP6TPC9008	28.00	32.00	1000PCS



# A2013 PA

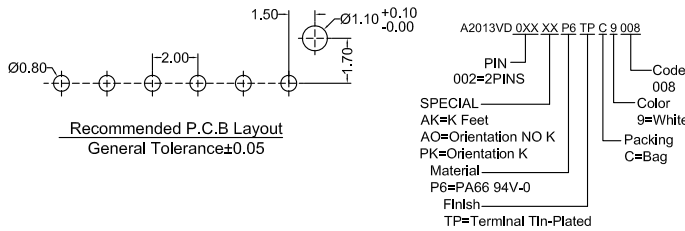
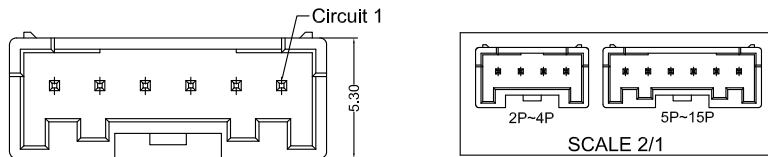
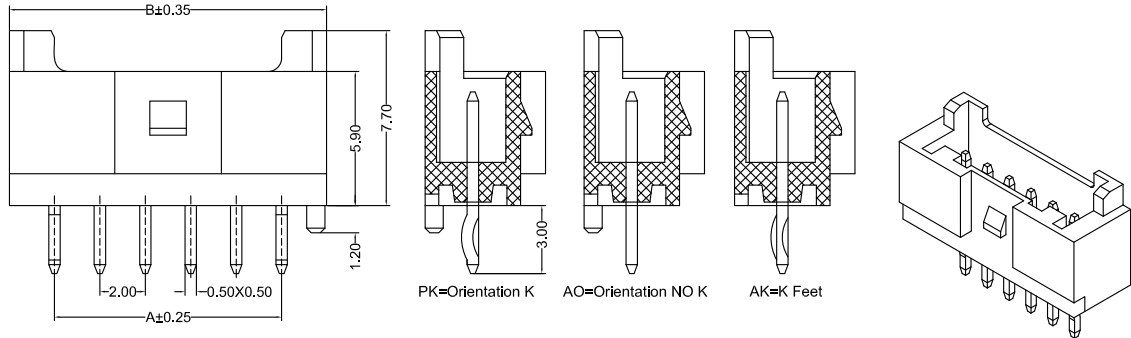

CSG PART NO.	Dimension mm		Q'ty/BAG
	A	B	
A2013VD002XXP6TPC9008	2.00	6.00	1000PCS
A2013VD003XXP6TPC9008	4.00	8.00	1000PCS
A2013VD004XXP6TPC9008	6.00	10.00	1000PCS
A2013VD005XXP6TPC9008	8.00	12.00	1000PCS
A2013VD006XXP6TPC9008	10.00	14.00	1000PCS
A2013VD007XXP6TPC9008	12.00	16.00	1000PCS
A2013VD008XXP6TPC9008	14.00	18.00	1000PCS
A2013VD009XXP6TPC9008	16.00	20.00	1000PCS
A2013VD010XXP6TPC9008	18.00	22.00	1000PCS
A2013VD011XXP6TPC9008	20.00	24.00	1000PCS
A2013VD012XXP6TPC9008	22.00	26.00	1000PCS
A2013VD013XXP6TPC9008	24.00	28.00	1000PCS
A2013VD014XXP6TPC9008	26.00	30.00	1000PCS
A2013VD015XXP6TPC9008	28.00	32.00	1000PCS

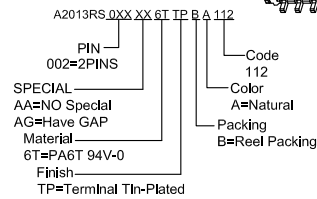
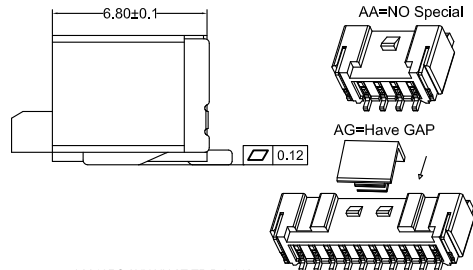
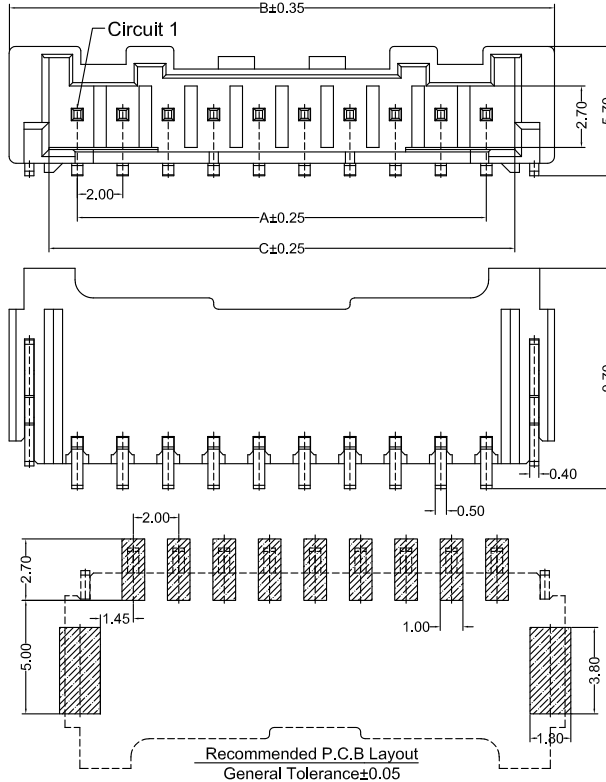

CSG PART NO.	Dimension mm			Q'ty/Reel
	A	B	C	
A2013RS002XX6TTPBA112	2.00	8.00	4.55	700PCS
A2013RS003XX6TTPBA112	4.00	10.00	6.55	700PCS
A2013RS004XX6TTPBA112	6.00	12.00	8.55	700PCS
A2013RS005XX6TTPBA112	8.00	14.00	10.55	700PCS
A2013RS006XX6TTPBA112	10.00	16.00	12.55	700PCS
A2013RS007XX6TTPBA112	12.00	18.00	14.55	700PCS
A2013RS008XX6TTPBA112	14.00	20.00	16.55	700PCS
A2013RS009XX6TTPBA112	16.00	22.00	18.55	700PCS
A2013RS010XX6TTPBA112	18.00	24.00	20.55	700PCS
A2013RS011XX6TTPBA112	20.00	26.00	22.55	700PCS
A2013RS012XX6TTPBA112	22.00	28.00	24.55	700PCS
A2013RS013XX6TTPBA112	24.00	30.00	26.55	700PCS
A2013RS014XX6TTPBA112	26.00	32.00	28.55	700PCS
A2013RS015XX6TTPBA112	28.00	34.00	30.55	700PCS



# A2013 PA

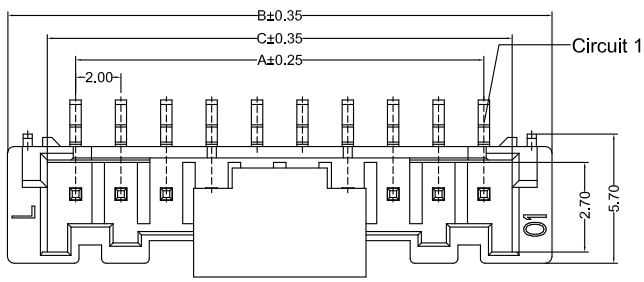
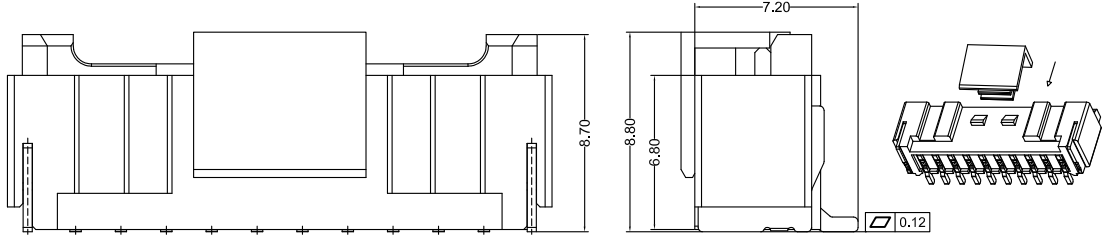

A2013VS 0XX AA 6T TP B A 112

PIN  
002=2PINS

SPECIAL \_\_\_\_\_  
AA=NO Special  
Material \_\_\_\_\_  
6T=PA6T 94V-0  
Finish \_\_\_\_\_  
TP=Terminal Tin-Plated

Code  
112  
Color  
A=Natural  
Packing  
B=Reel Packing

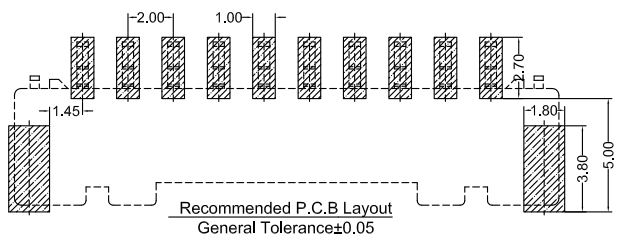

CSG PART NO.	Dimension mm			Q'ty/Reel
	A	B	C	
A2013VS002AA6TTPBA112	2.00	8.00	4.55	500PCS
A2013VS003AA6TTPBA112	4.00	10.00	6.55	500PCS
A2013VS004AA6TTPBA112	6.00	12.00	8.55	500PCS
A2013VS005AA6TTPBA112	8.00	14.00	10.55	500PCS
A2013VS006AA6TTPBA112	10.00	16.00	12.55	500PCS
A2013VS007AA6TTPBA112	12.00	18.00	14.55	500PCS
A2013VS008AA6TTPBA112	14.00	20.00	16.55	500PCS
A2013VS009AA6TTPBA112	16.00	22.00	18.55	500PCS
A2013VS010AA6TTPBA112	18.00	24.00	20.55	500PCS
A2013VS011AA6TTPBA112	20.00	26.00	22.55	500PCS
A2013VS012AA6TTPBA112	22.00	28.00	24.55	500PCS
A2013VS013AA6TTPBA112	24.00	30.00	26.55	500PCS
A2013VS014AA6TTPBA112	26.00	32.00	28.55	500PCS
A2013VS015AA6TTPBA112	28.00	34.00	30.55	500PCS

