

# A2541 CD-ROM CONNECTOR

2.54mm Pitch/Disconnectable Crimp style connectors

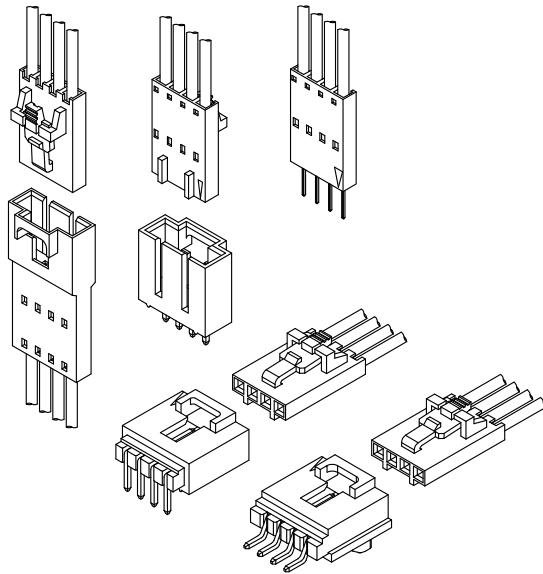

- Secure locking structure
- Low insertion force
- Suction area for picking up
- Improvement of engagement with prying

## Specifications:

- Current rating: 3.0 A / AC,DC (AWG #22)
- Voltage rating: 250 V AC/DC
- Temperature range: -25°C ~ +105°C  
(including temperature rise in applying electrical current)
- Contact resistance: Initial value/ 20mΩ max  
Insulation resistance: 1000 MΩ min  
Withstanding voltage: 1500 VAC/minute  
Applicable wire: Conductor size/ AWG#26~#22  
Insulation O.D./ 1.00 to 1.63 mm
- \* Compliant with RoHS2/ REACH
- \* Refer to "General Instruction and Notice when using Terminals and Connectors"
- \* Contact CSG for details

## Material:

Housing: PA66/UL94-V0;Color:Black  
Terminal: Phosphor/ Gold-Plated/ Tin-plated  
DIP Wafer Housing: PA66,UL94-V0;Color:Black/ White  
DIP Wafer Pin: Bass/ Gold-Plated/ Tin-plated  
SMT Wafer Housing: PA9T,UL94-V0;Color:Black  
SMT Wafer Pin: Bass/ Gold-Plated

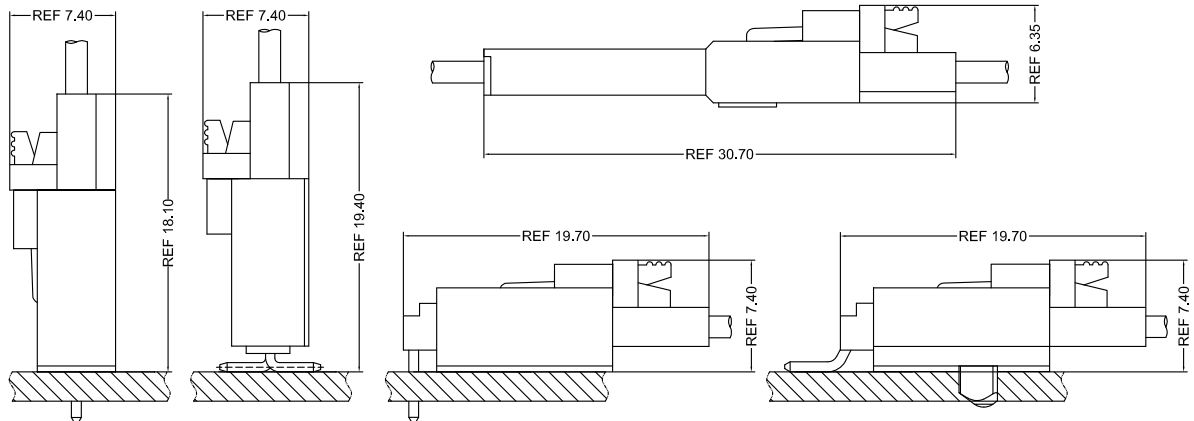

- Note: 1. The above figure is the figure viewed from the connector mounting side.  
2. Tolerances are non-cumulative:  $\pm 0.08$  mm for all centers.  
3. The dimensions above should serve as a guideline. Contact CSG for details.

**CSG**

Tel: +86-769-85312070 85375507 E-mail: James@cs-g-china.com www.csg-china.com www.jst-connector.cn

# A2541 CD-ROM

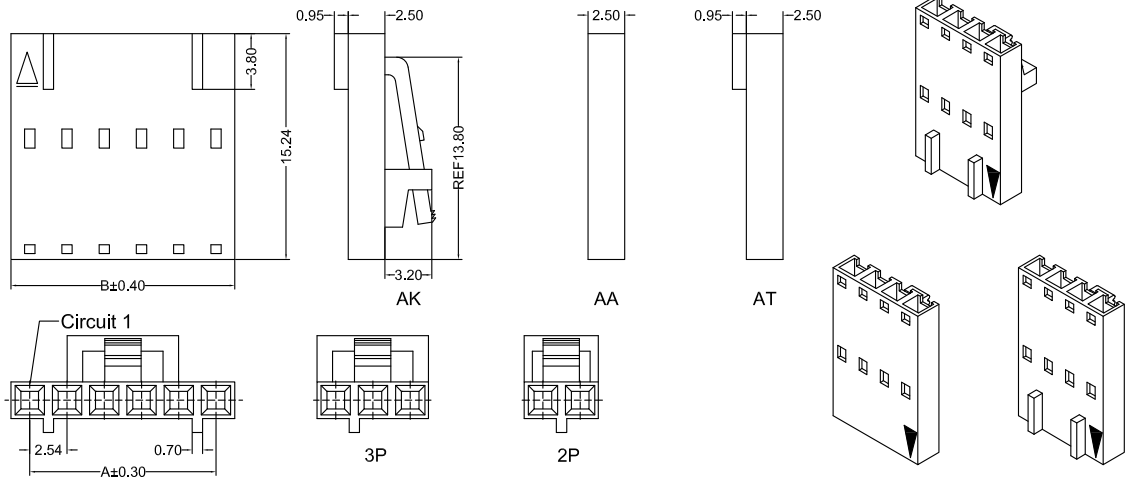

A2541HF 0XX XX P6 0 XXX

PIN  
005=5PINS

SPECIAL  
AA=NO Special  
AK=BUCKLE  
AT=Have BOSS

Material  
P6=PA66 94V-0

Code  
005  
010

Color  
0=Black

CSG PART NO.	Dimension mm		Qty/BAG
	A	B	
A2541HF002XXP60XXX	2.54	5.08	1000PCS
A2541HF003XXP60XXX	5.08	7.62	1000PCS
A2541HF004XXP60XXX	7.62	10.16	1000PCS
A2541HF005XXP60XXX	10.16	12.70	1000PCS
A2541HF006XXP60XXX	12.70	15.24	1000PCS
A2541HF007XXP60XXX	15.24	17.18	1000PCS
A2541HF008XXP60XXX	17.78	20.32	1000PCS
A2541HF009XXP60XXX	20.32	22.86	1000PCS
A2541HF010XXP60XXX	22.86	25.40	1000PCS
A2541HF011XXP60XXX	25.40	27.94	1000PCS
A2541HF012XXP60XXX	27.94	30.48	1000PCS
A2541HF013XXP60XXX	30.48	33.02	1000PCS
A2541HF014XXP60XXX	33.02	35.56	1000PCS
A2541HF015XXP60XXX	35.56	38.10	1000PCS

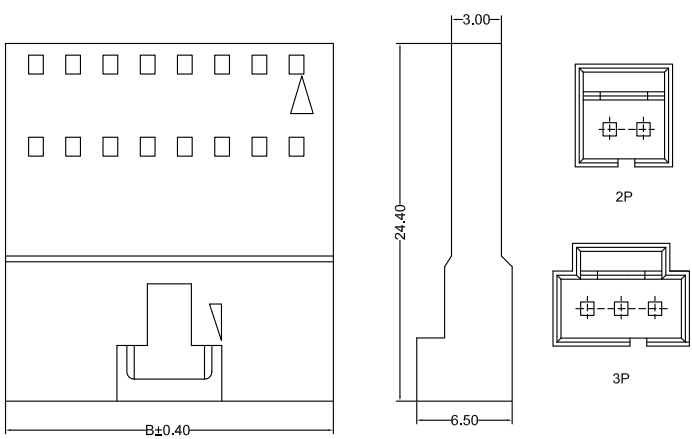

A2541HM 0XX AA P6 0 XXX

PIN  
005=5PINS

SPECIAL  
AA=NO Special

Material  
P6=PA66 94V-0

Code  
005  
010

Color  
0=Black

CSG PART NO.	Dimension mm		Qty/BAG
	A	B	
A2541HM002AAP60XXX	2.54	7.12	1000PCS
A2541HM003AAP60XXX	5.08	9.66	1000PCS
A2541HM004AAP60XXX	7.62	12.20	1000PCS
A2541HM005AAP60XXX	10.16	14.74	1000PCS
A2541HM006AAP60XXX	12.70	17.28	1000PCS
A2541HM007AAP60XXX	15.24	19.82	1000PCS
A2541HM008AAP60XXX	17.78	22.36	1000PCS
A2541HM009AAP60XXX	20.32	24.90	1000PCS
A2541HM010AAP60XXX	22.86	27.44	1000PCS
A2541HM011AAP60XXX	25.40	29.98	1000PCS
A2541HM012AAP60XXX	27.94	32.52	1000PCS
A2541HM013AAP60XXX	30.48	35.06	1000PCS
A2541HM014AAP60XXX	33.02	37.60	1000PCS
A2541HM015AAP60XXX	35.56	40.14	1000PCS
A2541HM016AAP60XXX	38.10	42.68	1000PCS
A2541HM017AAP60XXX	40.64	45.22	1000PCS
A2541HM018AAP60XXX	43.18	47.76	1000PCS
A2541HM019AAP60XXX	45.72	50.30	1000PCS
A2541HM020AAP60XXX	48.26	52.84	1000PCS



# A2541 CD-ROM

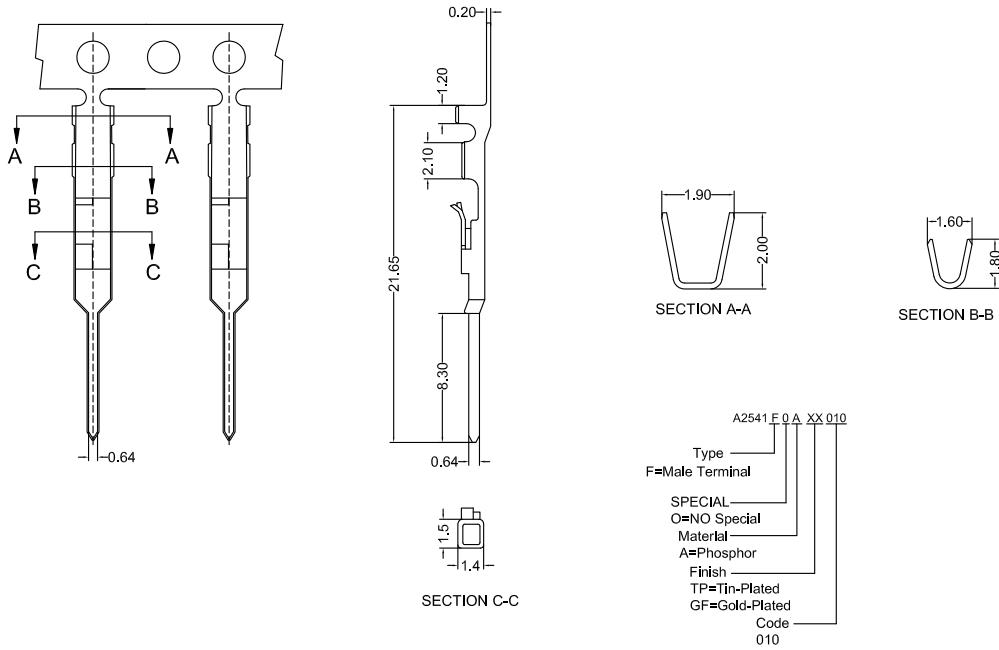

CSG PART NO.	Wire Range	Insulation O.D.	Q'ty/Reel
A2541F0ATP010	AWG#22~#26	1.63mm(max)	10000PCS
A2541F0AGF010	AWG#22~#26	1.63mm(max)	10000PCS

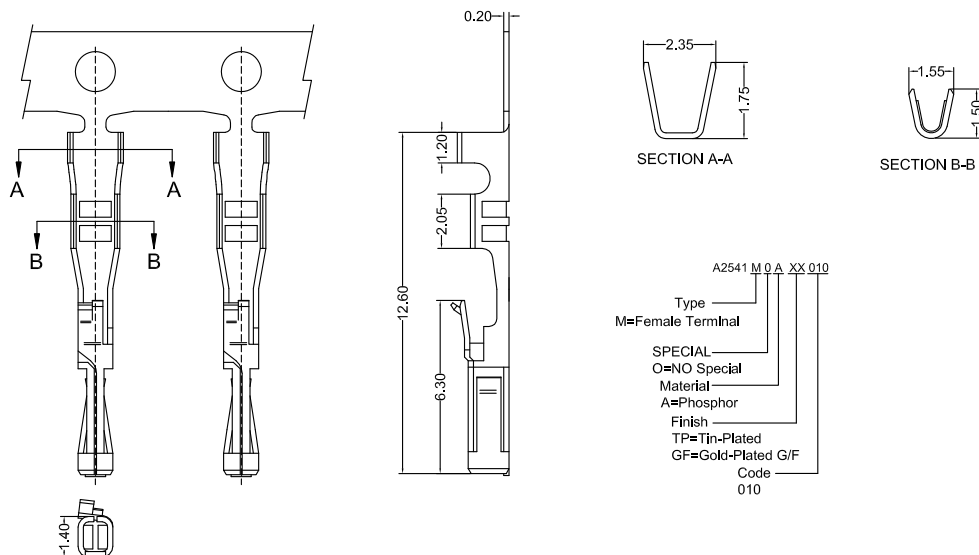

CSG PART NO.	Wire Range	Insulation O.D.	Q'ty/Reel
A2541M0ATP010	AWG#22~#26	1.63mm(max)	10000PCS
A2541M0AGF010	AWG#22~#26	1.63mm(max)	10000PCS



# A2541 CD-ROM

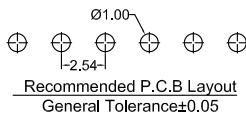
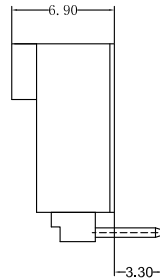
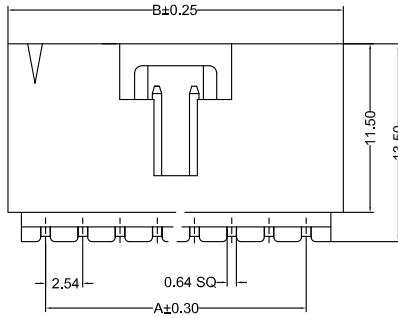
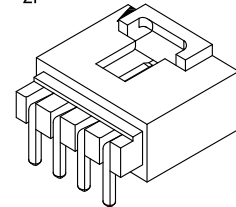
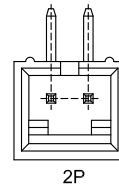
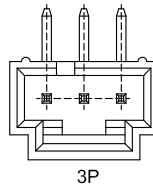
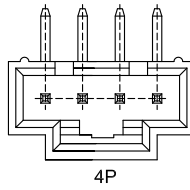
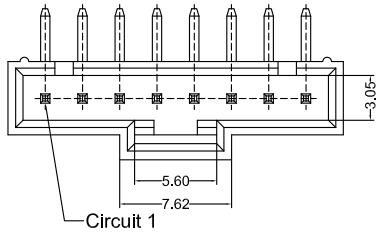

A2541RD.0XX AA P6 XX C 0 010  
 PIN 002=2PINS  
 SPECIAL AA=NO Special  
 Material P6=PA66 94V-0  
 Finish GF=Terminal Gold-Plated  
 TP=Terminal Tin-Plated  
 Code 010  
 Color 0=Black  
 Packing C=Bag

CSG PART NO.	Dimension mm		Q'ty/BAG
	A	B	
A2541RD002AAP6XXC0010	2.54	7.62	1000PCS
A2541RD003AAP6XXC0010	5.08	10.16	1000PCS
A2541RD004AAP6XXC0010	7.62	12.70	1000PCS
A2541RD005AAP6XXC0010	10.16	15.24	1000PCS
A2541RD006AAP6XXC0010	12.70	17.18	1000PCS
A2541RD007AAP6XXC0010	15.24	20.32	1000PCS
A2541RD008AAP6XXC0010	17.18	22.86	1000PCS
A2541RD009AAP6XXC0010	20.32	25.40	1000PCS
A2541RD010AAP6XXC0010	22.86	27.94	1000PCS
A2541RD011AAP6XXC0010	25.40	30.48	1000PCS
A2541RD012AAP6XXC0010	27.94	33.02	1000PCS
A2541RD013AAP6XXC0010	30.48	35.56	1000PCS
A2541RD014AAP6XXC0010	33.02	38.10	1000PCS
A2541RD015AAP6XXC0010	35.56	40.64	1000PCS
A2541RD016AAP6XXC0010	38.10	43.18	1000PCS
A2541RD017AAP6XXC0010	40.64	45.72	1000PCS
A2541RD018AAP6XXC0010	43.18	48.26	1000PCS
A2541RD019AAP6XXC0010	45.72	50.80	1000PCS
A2541RD020AAP6XXC0010	48.26	53.34	1000PCS

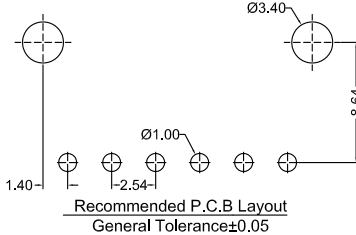
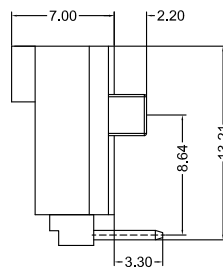
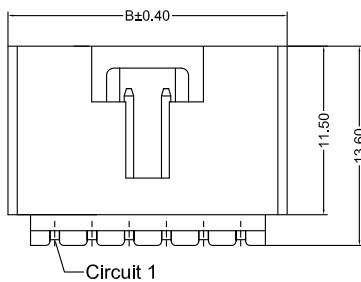
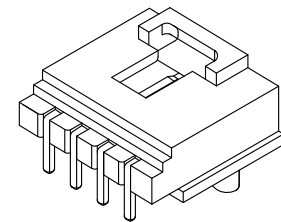
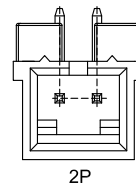
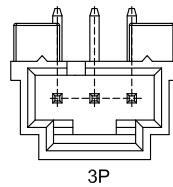
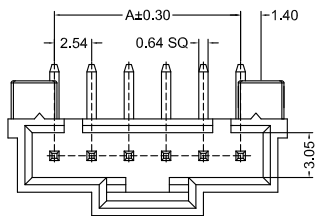

A2541RD.0XX AP 9T GF C 0 010  
 PIN 002=2PINS  
 SPECIAL AP=Pin Pillars  
 Material 9T=PA9T 94V-0  
 Finish GF=Terminal Gold-Plated  
 Code 010  
 Color 0=Black  
 Packing C=Bag

CSG PART NO.	Dimension mm		Q'ty/BAG
	A	B	
A2541RD002AP9TGFC0010	2.54	8.89	1000PCS
A2541RD003AP9TGFC0010	5.08	10.16	1000PCS
A2541RD004AP9TGFC0010	7.62	12.70	1000PCS
A2541RD005AP9TGFC0010	10.16	15.24	1000PCS
A2541RD006AP9TGFC0010	12.70	17.18	1000PCS
A2541RD007AP9TGFC0010	15.24	20.32	1000PCS
A2541RD008AP9TGFC0010	17.18	22.86	1000PCS
A2541RD009AP9TGFC0010	20.32	25.40	1000PCS
A2541RD010AP9TGFC0010	22.86	27.94	1000PCS
A2541RD011AP9TGFC0010	25.40	30.48	1000PCS
A2541RD012AP9TGFC0010	27.94	33.02	1000PCS



# A2541 CD-ROM

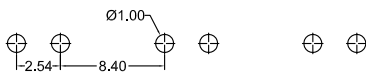
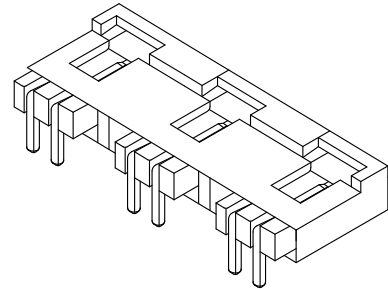
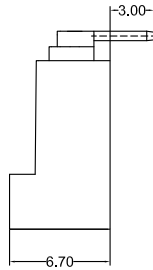
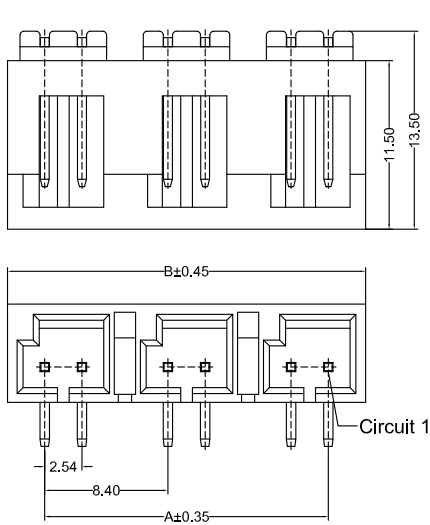

Recommended P.C.B Layout  
General Tolerance±0.05

A2541RD 1XX AA P6 GF C X 001  
 PIN 102=1X2PINS  
 SPECIAL  
 AA=NO Special  
 Material P6=PA66 94V-0  
 Finish GF=Terminal Gold-Plated  
 TP=Terminal Tin-Plated  
 Code 001  
 Color 0=Black 9=White  
 Packing C=Bag

CSG PART NO.	Dimension mm		Q'ty/BAG
	A	B	
A2541RD101AAP6XXCX001	2.54	7.62	1000PCS
A2541RD102AAP6XXCX001	10.94	16.02	1000PCS
A2541RD103AAP6XXCX001	19.34	24.42	1000PCS
A2541RD104AAP6XXCX001	27.74	32.82	1000PCS
A2541RD105AAP6XXCX001	36.14	43.10	1000PCS
A2541RD106AAP6XXCX001	44.54	49.65	1000PCS

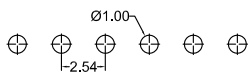
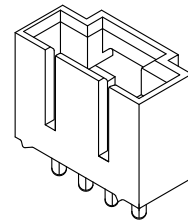
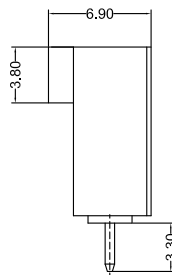
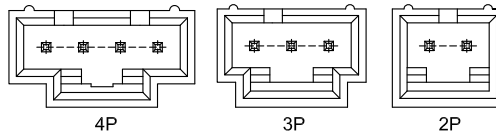
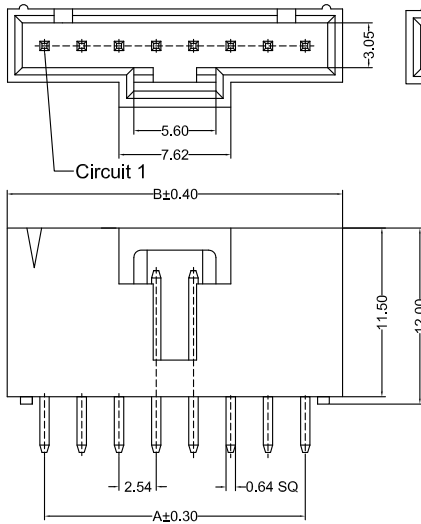

Recommended P.C.B Layout  
General Tolerance±0.05

A2541VD 0XX AA P6 XX C 0 010  
 PIN 002=2PINS  
 SPECIAL  
 AA=NO Special  
 Material P6=PA66 94V-0  
 Finish GF=Terminal Gold-Plated  
 TP=Terminal Tin-Plated  
 Code 010  
 Color 0=Black  
 Packing C=Bag

CSG PART NO.	Dimension mm		Q'ty/BAG
	A	B	
A2541VD002AAP6XXC0010	2.54	7.62	1000PCS
A2541VD003AAP6XXC0010	5.08	10.16	1000PCS
A2541VD004AAP6XXC0010	7.62	12.70	1000PCS
A2541VD005AAP6XXC0010	10.16	15.24	1000PCS
A2541VD006AAP6XXC0010	12.70	17.18	1000PCS
A2541VD007AAP6XXC0010	15.24	20.32	1000PCS
A2541VD008AAP6XXC0010	17.18	22.86	1000PCS
A2541VD009AAP6XXC0010	20.32	25.40	1000PCS
A2541VD010AAP6XXC0010	22.86	27.94	1000PCS
A2541VD011AAP6XXC0010	25.40	30.48	1000PCS
A2541VD012AAP6XXC0010	27.94	33.02	1000PCS
A2541VD013AAP6XXC0010	30.48	35.56	1000PCS
A2541VD014AAP6XXC0010	33.02	38.10	1000PCS
A2541VD015AAP6XXC0010	35.56	40.64	1000PCS
A2541VD016AAP6XXC0010	38.10	43.18	1000PCS
A2541VD017AAP6XXC0010	40.64	45.72	1000PCS
A2541VD018AAP6XXC0010	43.18	48.26	1000PCS
A2541VD019AAP6XXC0010	45.72	50.80	1000PCS
A2541VD020AAP6XXC0010	48.26	53.34	1000PCS



# A2541 CD-ROM

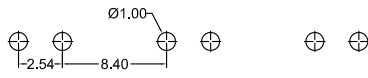
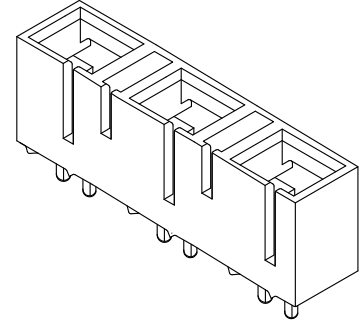
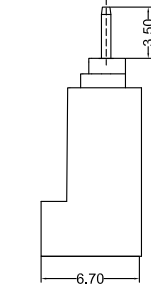
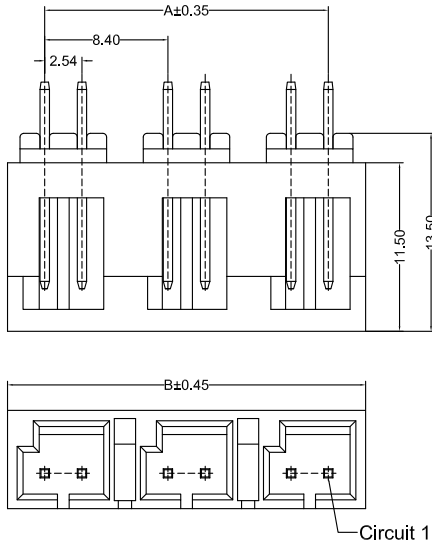

Recommended P.C.B Layout  
General Tolerance  $\pm 0.05$

A2541VD1XXAA P6 GF C X 001  
 PIN  
 102=1X2PINS  
 SPECIAL  
 AA=NO Special  
 Material  
 P6=PA66 94V-0  
 Finish  
 GF=Terminal Gold-Plated  
 TP=Terminal Tin-Plated  
 Code  
 001  
 Color  
 0=Black  
 9=White  
 Packing  
 C=Bag

CSG PART NO.	Dimension mm		Q'ty/BAG
	A	B	
A2541VD101AAP6XXCX001	2.54	7.62	1000PCS
A2541VD102AAP6XXCX001	10.94	16.02	1000PCS
A2541VD103AAP6XXCX001	19.34	24.42	1000PCS
A2541VD104AAP6XXCX001	27.74	32.82	1000PCS
A2541VD105AAP6XXCX001	36.14	43.10	1000PCS
A2541VD106AAP6XXCX001	44.54	49.65	1000PCS

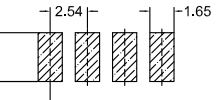
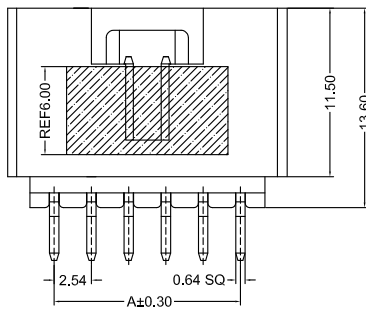
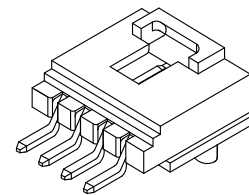
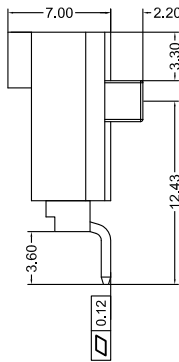
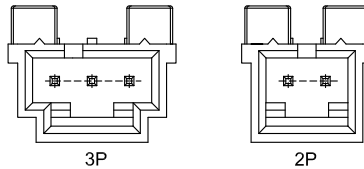
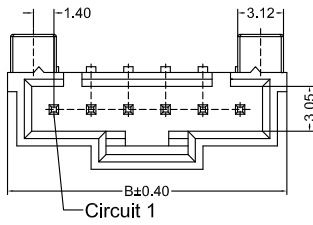

Recommended P.C.B Layout  
General Tolerance  $\pm 0.05$

A2541RS0XXAP9T GF B 0 010  
 PIN  
 002=2PINS  
 SPECIAL  
 AP=Pillars  
 Material  
 9T=PA9T 94V-0  
 Finish  
 GF=Terminal Gold-Plated  
 Code  
 010  
 Color  
 0=Black  
 Packing  
 B=Reel

CSG PART NO.	Dimension mm		Q'ty/Reel
	A	B	
A2541RS002AP9TGFB0010	2.54	8.89	250PCS
A2541RS003AP9TGFB0010	5.08	10.16	250PCS
A2541RS004AP9TGFB0010	7.62	12.70	250PCS
A2541RS005AP9TGFB0010	10.16	15.24	250PCS
A2541RS006AP9TGFB0010	12.70	17.18	250PCS
A2541RS007AP9TGFB0010	15.24	20.32	250PCS
A2541RS008AP9TGFB0010	17.18	22.86	250PCS
A2541RS009AP9TGFB0010	20.32	25.40	250PCS
A2541RS010AP9TGFB0010	22.86	27.94	250PCS
A2541RS011AP9TGFB0010	25.40	30.48	250PCS
A2541RS012AP9TGFB0010	27.94	33.02	250PCS



# A2541 CD-ROM

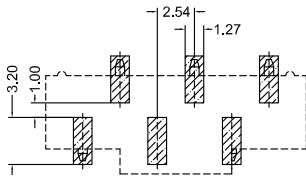
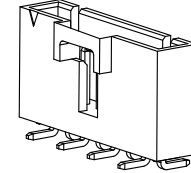
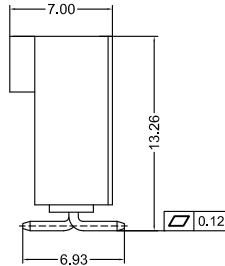
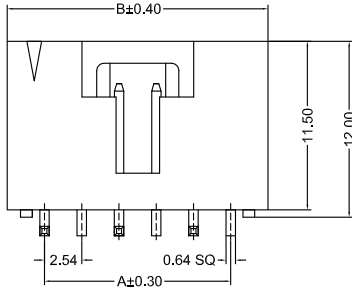
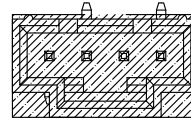
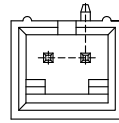
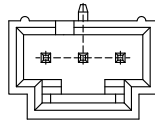
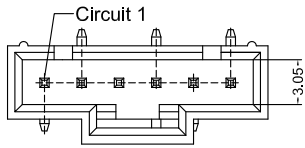

Recommended P.C.B Layout  
General Tolerance±0.05

A2541VS\_0XX AA 9T GF B 0 010

PIN  
002=2PINS

SPECIAL  
AA=NO Spectal

Material  
9T=PA9T 94V-0

Finsh  
GF=Terminal Gold-Plated

Code  
010  
Color  
0=Black

Packing  
B=Reel

CSG PART NO.	Dimension mm		Q'ty/Reel
	A	B	
A2541VS002AA9TGF0010	2.54	7.62	200PCS
A2541VS003AA9TGF0010	5.08	10.16	200PCS
A2541VS004AA9TGF0010	7.62	12.70	200PCS
A2541VS005AA9TGF0010	10.16	15.24	200PCS
A2541VS006AA9TGF0010	12.70	17.18	200PCS
A2541VS007AA9TGF0010	15.24	20.32	200PCS
A2541VS008AA9TGF0010	17.18	22.86	200PCS
A2541VS009AA9TGF0010	20.32	25.40	200PCS
A2541VS010AA9TGF0010	22.86	27.94	200PCS
A2541VS011AA9TGF0010	25.40	30.48	200PCS
A2541VS012AA9TGF0010	27.94	33.02	200PCS
A2541VS013AA9TGF0010	30.48	35.56	200PCS
A2541VS014AA9TGF0010	33.02	38.10	200PCS
A2541VS015AA9TGF0010	35.56	40.64	200PCS
A2541VS016AA9TGF0010	38.10	43.18	200PCS
A2541VS017AA9TGF0010	40.64	45.72	200PCS
A2541VS018AA9TGF0010	43.18	48.26	200PCS
A2541VS019AA9TGF0010	45.72	50.80	200PCS
A2541VS020AA9TGF0010	48.26	53.34	200PCS