

# A1250 51021 CONNECTOR

1.25mm Pitch/Disconnectable Crimp style connectors

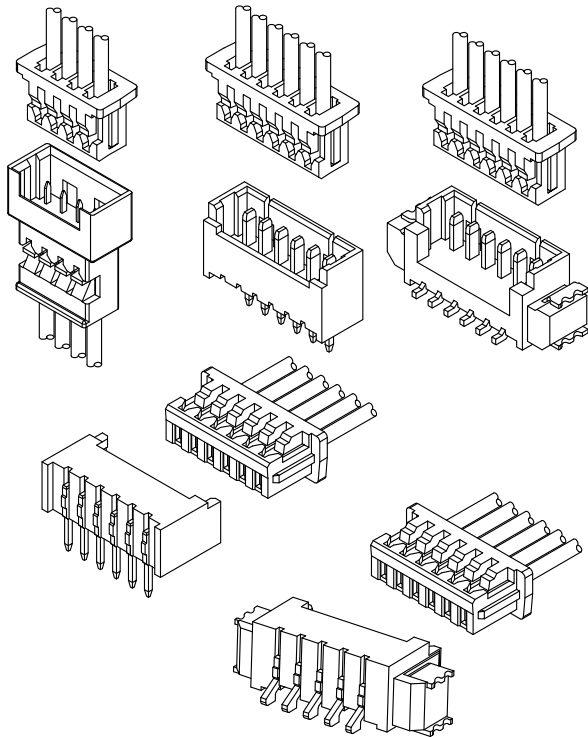

- Secure lock device
- Low insertion force
- Prevention of contact deformation
- Suction area for picking up

## Specifications:

- Current rating: 1.0 A / AC,DC
- Voltage rating: 125 V AC/DC
- Temperature range: -40°C ~ +105°C  
(including temperature rise in applying electrical current)
- Contact resistance: Initial value/ 20m Ω max  
Insulation resistance: 100 M Ω min  
Withstanding voltage: 500 VAC/minute  
Applicable wire: Conductor size/ AWG#32~#28  
Insulation O.D./ 0.38 to 1.00 mm
- \* Compliant with RoHS2/ REACH
- \* Refer to "General Instruction and Notice when using Terminals and Connectors"
- \* Contact CSG for details

## Material:

Housing: PA66/UL94-V0;Color:White/ Black  
Terminal: Phosphor/ Tin-plated,Gold-Plated  
DIP Wafer Housing: PA46/ PA66/ LCP,UL94-V0;  
Color:White/ Gray  
DIP Wafer Pin: Phosphor/ Tin-plated,Gold-Plated  
SMT Wafer Housing: LCP,UL94-V0;Color:Natural  
SMT Wafer Pin: Phosphor/ Tin-plated,Gold-Plated  
Wafer Fixed Foot: Bass/ Tin-plated

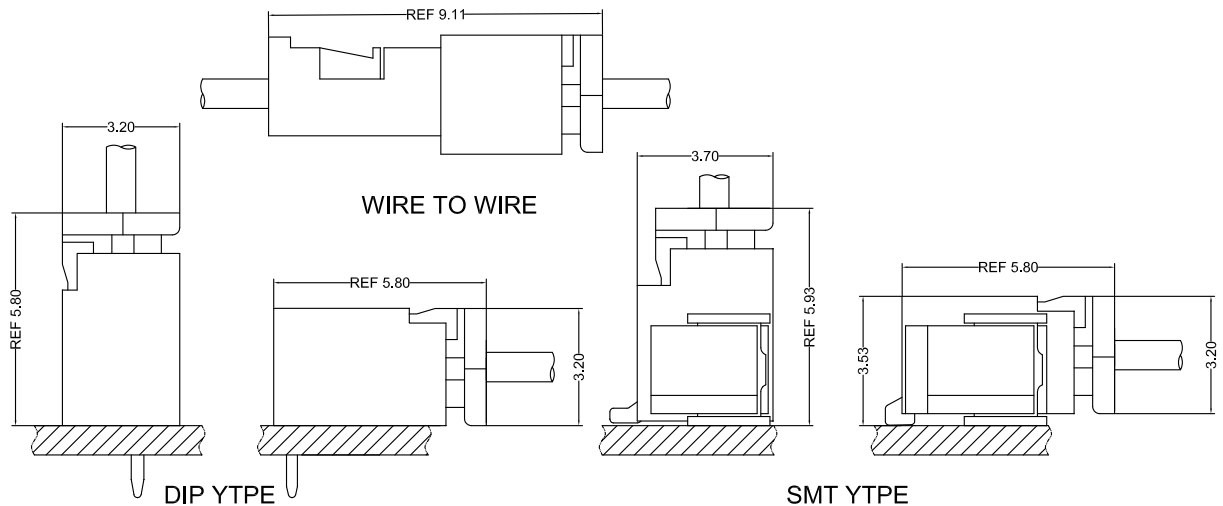

- Note: 1. The above figure is the figure viewed from the connector mounting side.  
2. Tolerances are non-cumulative:  $\pm 0.08$  mm for all centers.  
3. The dimensions above should serve as a guideline. Contact CSG for details.

**CSG**

Tel: +86-769-85312070 85375507 E-mail: James@csg-china.com www.csg-china.com www.jst-connector.cn

# A1250 51021

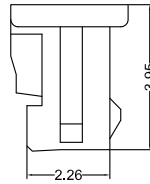
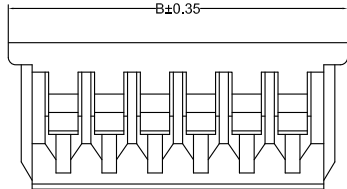
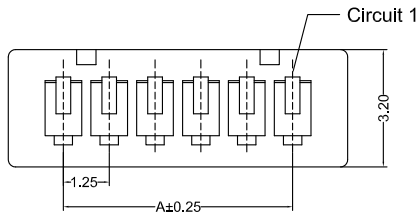

A1250HF 0XX AA P6 X 005  
 PIN  
 005=5PINS  
 SPECIAL  
 AA=NO Special  
 AC=Breach  
 Material  
 P6=PA66 94V-0  
 Code  
 005  
 Color  
 9=White  
 0=Black

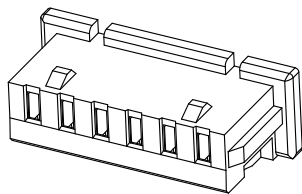
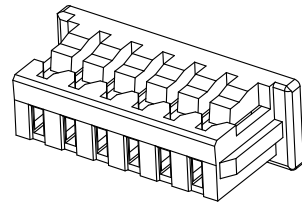

AC=Breach

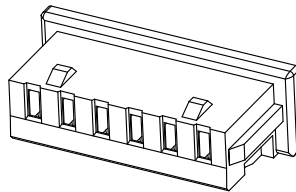

AA=NO Special

CSG PART NO.	Dimension mm		Q'ty/BAG
	A	B	
A1250HF002XXP6X005	1.25	4.25	1000PCS
A1250HF003XXP6X005	2.50	5.50	1000PCS
A1250HF004XXP6X005	3.75	6.75	1000PCS
A1250HF005XXP6X005	5.00	8.00	1000PCS
A1250HF006XXP6X005	6.25	9.25	1000PCS
A1250HF007XXP6X005	7.50	10.50	1000PCS
A1250HF008XXP6X005	8.75	11.75	1000PCS
A1250HF009XXP6X005	10.00	13.00	1000PCS
A1250HF010XXP6X005	11.25	14.25	1000PCS
A1250HF011XXP6X005	12.50	15.50	1000PCS
A1250HF012XXP6X005	13.75	16.75	1000PCS
A1250HF013XXP6X005	15.00	18.00	1000PCS
A1250HF014XXP6X005	16.25	19.25	1000PCS
A1250HF015XXP6X005	17.50	20.50	1000PCS
A1250HF016XXP6X005	18.75	21.75	1000PCS

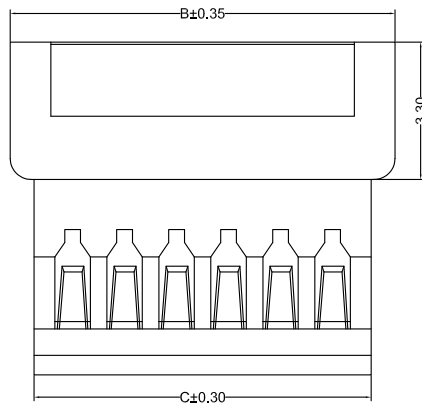
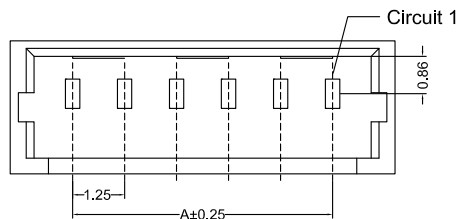

A1250HM 0XX AA P6 X 005  
 PIN  
 005=5PINS  
 SPECIAL  
 AA=NO Special  
 Material  
 P6=PA66 94V-0  
 Code  
 005  
 Color  
 9=White  
 0=Black

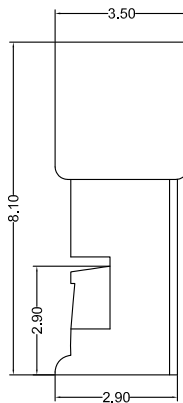
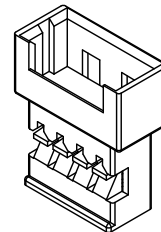

CSG PART NO.	Dimension mm			Q'ty/BAG
	A	B	C	
A1250HM002XXP6X005	1.25	4.40	3.10	1000PCS
A1250HM003XXP6X005	2.50	5.65	4.35	1000PCS
A1250HM004XXP6X005	3.75	6.90	5.60	1000PCS
A1250HM005XXP6X005	5.00	8.15	6.85	1000PCS
A1250HM006XXP6X005	6.25	9.40	8.10	1000PCS
A1250HM007XXP6X005	7.50	10.65	9.35	1000PCS
A1250HM008XXP6X005	8.75	11.90	10.60	1000PCS
A1250HM009XXP6X005	10.00	13.15	11.85	1000PCS
A1250HM010XXP6X005	11.25	14.50	13.10	1000PCS
A1250HM011XXP6X005	12.50	15.65	14.35	1000PCS
A1250HM012XXP6X005	13.75	16.90	15.60	1000PCS
A1250HM013XXP6X005	15.00	18.15	16.85	1000PCS
A1250HM014XXP6X005	16.25	19.40	18.10	1000PCS
A1250HM015XXP6X005	17.50	20.65	19.35	1000PCS
A1250HM016XXP6X005	18.75	21.90	20.60	1000PCS



# A1250 51021

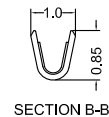
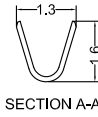
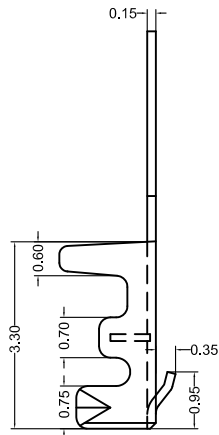
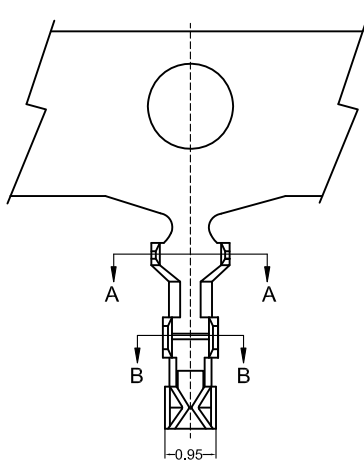

A1250 M 0 A XX 002  
 Type ——— M=Female Terminal  
 Material ——— A=Phosphor  
 Finish ——— TP=Tin-Plated  
               GF=Gold-Plated G/F  
 Code ——— 002

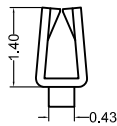

CSG PART NO.	Wire Range	Insulation O.D.	Q'ty/Reel
A1250M0ATP002	AWG#28-#32	1.00mm(max)	15000PCS
A1250M0AGF002	AWG#28-#32	1.00mm(max)	15000PCS

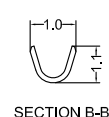
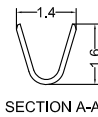
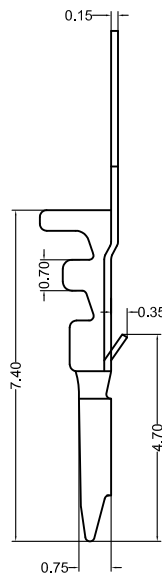
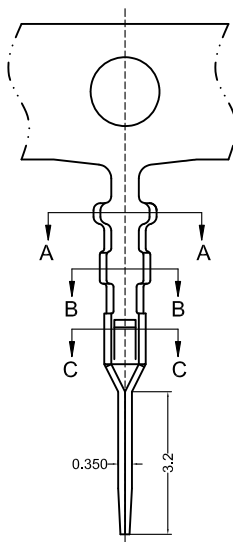

A1250 E 0 A TP 012  
 Type ——— F=Male Terminal  
 Material ——— A=Phosphor  
 Finish ——— TP=Tin-Plated  
 Code ——— 012

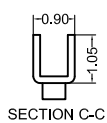

CSG PART NO.	Wire Range	Insulation O.D.	Q'ty/Reel
A1250F0ATP012	AWG#28-#32	1.00mm(max)	20000PCS



# A1250 51021

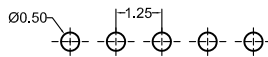
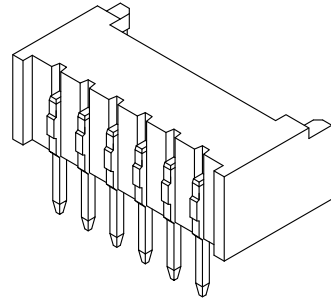
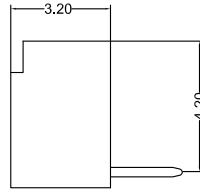
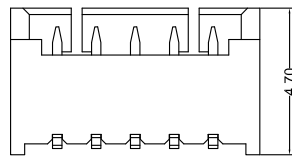
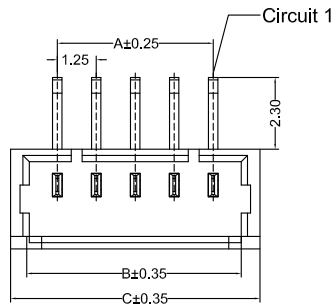

Recommended P.C.B Layout  
General Tolerance±0.05

A1250RD 0XX AA PX XX C X 008

- PIN 005=5PINS
- SPECIAL AA=NO Special
- Material P4=PA46 94V-0 P6=PA66 94V-0
- Finish TP=Terminal Tin-Plated GF=Terminal Gold-Plated
- Code 008
- Color 8=Gray 9=White
- Packing C=Bag

CSG PART NO.	Dimension mm			Q'ty/BAG
	A	B	C	
A1250RD002AAAXXXCX008	1.25	3.15	4.25	1000PCS
A1250RD003AAAXXXCX008	2.50	4.40	5.50	1000PCS
A1250RD004AAAXXXCX008	3.75	5.65	6.75	1000PCS
A1250RD005AAAXXXCX008	5.00	6.90	8.00	1000PCS
A1250RD006AAAXXXCX008	6.25	8.15	9.25	1000PCS
A1250RD007AAAXXXCX008	7.50	9.40	10.50	1000PCS
A1250RD008AAAXXXCX008	8.75	10.65	11.75	1000PCS
A1250RD009AAAXXXCX008	10.00	11.90	13.00	1000PCS
A1250RD010AAAXXXCX008	11.25	13.15	14.25	1000PCS
A1250RD011AAAXXXCX008	12.50	14.40	15.50	1000PCS
A1250RD012AAAXXXCX008	13.75	15.65	16.75	1000PCS
A1250RD013AAAXXXCX008	15.00	16.90	18.00	1000PCS
A1250RD014AAAXXXCX008	16.25	18.15	19.25	1000PCS
A1250RD015AAAXXXCX008	17.50	19.40	20.50	1000PCS
A1250RD016AAAXXXCX008	18.75	20.65	21.75	1000PCS

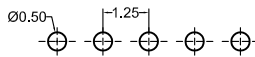
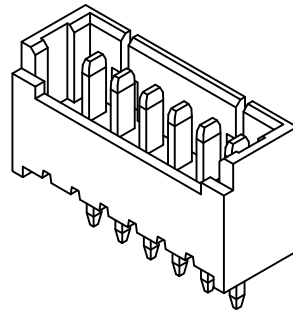
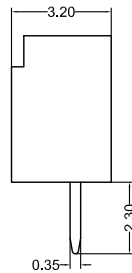
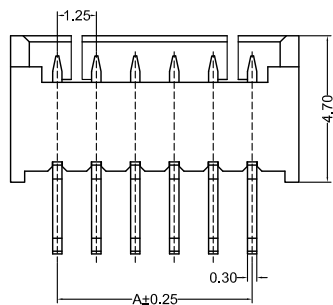
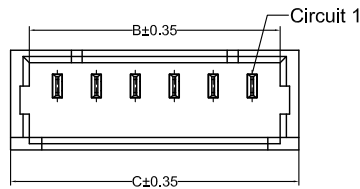

Recommended P.C.B Layout  
General Tolerance±0.05

A1250VD 0XX AA PX XX C X XXX

- PIN 005=5PINS
- SPECIAL AA=NO Special
- Material P4=PA46 94V-0 P6=PA66 94V-0 LP=LCP 94V-0
- Finish TP=Terminal Tin-Plated GF=Terminal Gold-Plated
- Code 008 112
- Color 8=Gray 9=White
- Packing C=Bag B=Tape & Reel

CSG PART NO.	Dimension mm			Q'ty/BAG
	A	B	C	
A1250VD002AAAXXXXXXXXX	1.25	3.15	4.25	1000PCS
A1250VD003AAAXXXXXXXXX	2.50	4.40	5.50	1000PCS
A1250VD004AAAXXXXXXXXX	3.75	5.65	6.75	1000PCS
A1250VD005AAAXXXXXXXXX	5.00	6.90	8.00	1000PCS
A1250VD006AAAXXXXXXXXX	6.25	8.15	9.25	1000PCS
A1250VD007AAAXXXXXXXXX	7.50	9.40	10.50	1000PCS
A1250VD008AAAXXXXXXXXX	8.75	10.65	11.75	1000PCS
A1250VD009AAAXXXXXXXXX	10.00	11.90	13.00	1000PCS
A1250VD010AAAXXXXXXXXX	11.25	13.15	14.25	1000PCS
A1250VD011AAAXXXXXXXXX	12.50	14.40	15.50	1000PCS
A1250VD012AAAXXXXXXXXX	13.75	15.65	16.75	1000PCS
A1250VD013AAAXXXXXXXXX	15.00	16.90	18.00	1000PCS
A1250VD014AAAXXXXXXXXX	16.25	18.15	19.25	1000PCS
A1250VD015AAAXXXXXXXXX	17.50	19.40	20.50	1000PCS
A1250VD016AAAXXXXXXXXX	18.75	20.65	21.75	1000PCS



# A1250 51021

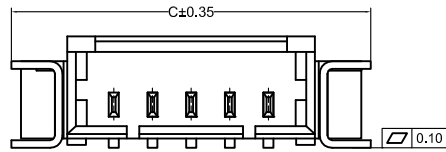
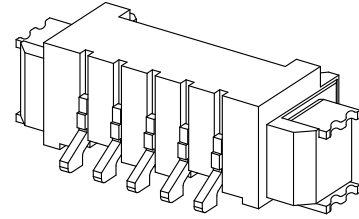
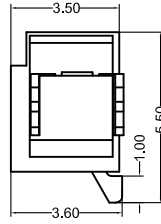
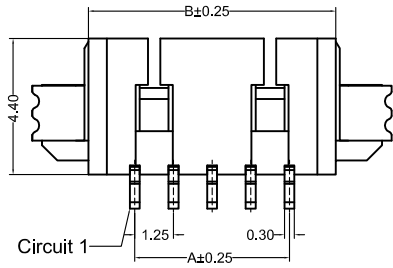

A1250RS\_0XX AA LP XX B 8 112

PIN  
005=5PINS  
SPECIAL  
AA=NO Special

Material  
LP=LCP 94V-0

Finish  
TP=Terminal Tin-Plated  
GF=Terminal Gold-Plated

Code  
112  
Color  
8=Gray

Packing  
B=Tape & Reel

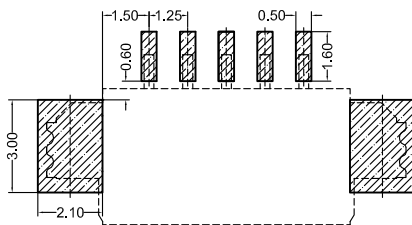

Recommended P.C.B Layout  
General Tolerance±0.05

CSG PART NO.	Dimension mm			Q'ty/Reel
	A	B	C	
A1250RS002AALPXXB8112	1.25	4.25	7.75	1500PCS
A1250RS003AALPXXB8112	2.50	5.50	9.00	1500PCS
A1250RS004AALPXXB8112	3.75	6.75	10.25	1500PCS
A1250RS005AALPXXB8112	5.00	8.00	11.50	1500PCS
A1250RS006AALPXXB8112	6.25	9.25	12.75	1500PCS
A1250RS007AALPXXB8112	7.50	10.50	14.00	1500PCS
A1250RS008AALPXXB8112	8.75	11.75	15.25	1500PCS
A1250RS009AALPXXB8112	10.00	13.00	16.50	1500PCS
A1250RS010AALPXXB8112	11.25	14.25	17.75	1500PCS
A1250RS011AALPXXB8112	12.50	15.50	19.00	1500PCS
A1250RS012AALPXXB8112	13.75	16.75	20.25	1500PCS
A1250RS013AALPXXB8112	15.00	18.00	21.50	1500PCS
A1250RS014AALPXXB8112	16.25	19.25	22.75	1500PCS
A1250RS015AALPXXB8112	17.50	20.50	24.00	1500PCS
A1250RS016AALPXXB8112	18.75	21.75	25.25	1500PCS

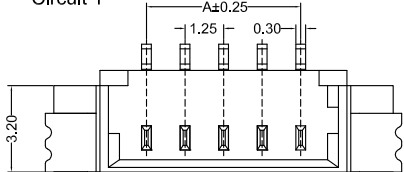
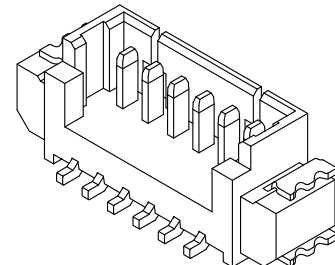
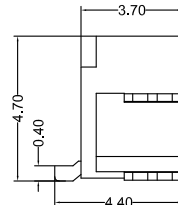
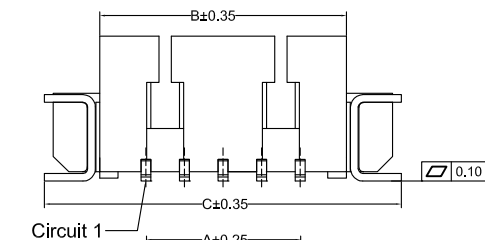

A1250VS\_0XX AA LP XX B 8 112

PIN  
005=5PINS  
SPECIAL  
AA=NO Special

Material  
LP=LCP 94V-0

Finish  
TP=Terminal Tin-Plated  
GF=Terminal Gold-Plated

Code  
112  
Color  
8=Gray

Packing  
B=Tape & Reel

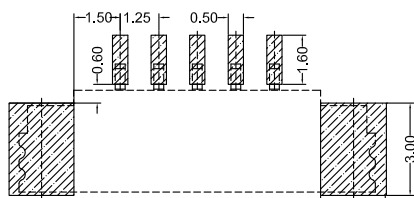

Recommended P.C.B Layout  
General Tolerance±0.05

CSG PART NO.	Dimension mm			Q'ty/Reel
	A	B	C	
A1250VS002AALPXXB8112	1.25	4.25	7.75	1000PCS
A1250VS003AALPXXB8112	2.50	5.50	9.00	1000PCS
A1250VS004AALPXXB8112	3.75	6.75	10.25	1000PCS
A1250VS005AALPXXB8112	5.00	8.00	11.50	1000PCS
A1250VS006AALPXXB8112	6.25	9.25	12.75	1000PCS
A1250VS007AALPXXB8112	7.50	10.50	14.00	1000PCS
A1250VS008AALPXXB8112	8.75	11.75	15.25	1000PCS
A1250VS009AALPXXB8112	10.00	13.00	16.50	1000PCS
A1250VS010AALPXXB8112	11.25	14.25	17.75	1000PCS
A1250VS011AALPXXB8112	12.50	15.50	19.00	1000PCS
A1250VS012AALPXXB8112	13.75	16.75	20.25	1000PCS
A1250VS013AALPXXB8112	15.00	18.00	21.50	1000PCS
A1250VS014AALPXXB8112	16.25	19.25	22.75	1000PCS
A1250VS015AALPXXB8112	17.50	20.50	24.00	1000PCS
A1250VS016AALPXXB8112	18.75	21.75	25.25	1000PCS

