

A2501 XH CONNECTOR

2.50mm Pitch/Disconnectable Crimp style connectors

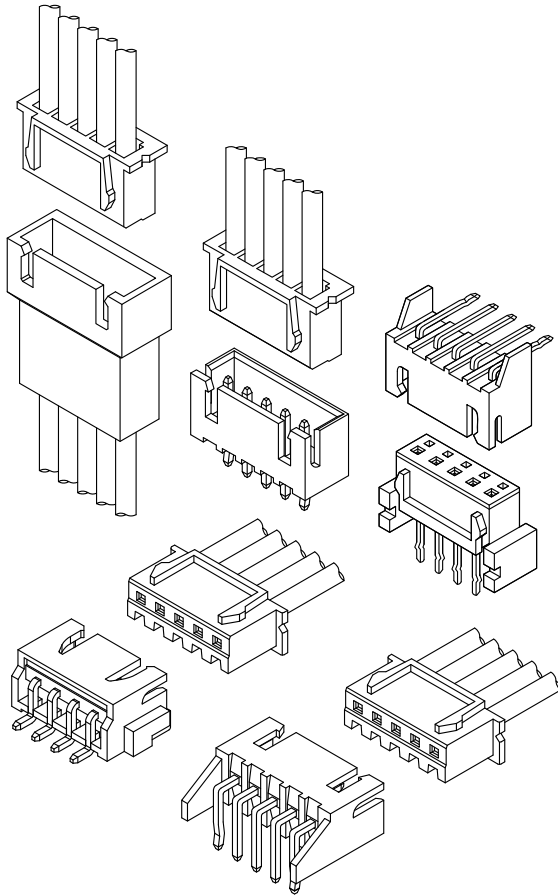

- Secure locking structure
- Low insertion force
- Suction area for picking up
- Improvement of engagement with prying

Specifications:

- Current rating: 3.0 A / AC,DC (AWG #22)
- Voltage rating: 250 V AC/DC
- Temperature range: -40°C ~ +105°C
(including temperature rise in applying electrical current)
- Contact resistance: Initial value/ 20mΩ max
Insulation resistance: 1000 MΩ min
Withstanding voltage: 1000 VAC/minute
Applicable wire: Conductor size/ AWG#28~#22
Insulation O.D./ 0.80 to 1.90 mm
- * Compliant with RoHS2/ HF/ REACH
- * Refer to "General Instruction and Notice when using Terminals and Connectors"
- * Contact CSG for details

Material:

Housing: PA66/UL94-V0;Color:White
Terminal: Phosphor/ Tin-plated
DIP Wafer Housing: PA66/ PA46,UL94-V0;
Color:White/ Natural
DIP Wafer Pin: Bass/ Tin-plated
SMT Wafer Housing: LCP,UL94-V0;Color:Natural
SMT Wafer Pin: Bass/ Tin-plated
SMT Wafer Fixed Foot: Bass/ Tin-plated
B TO B Housing: PA66,UL94-V0;Color:White
B TO B Pin: Phosphor/ Tin-plated

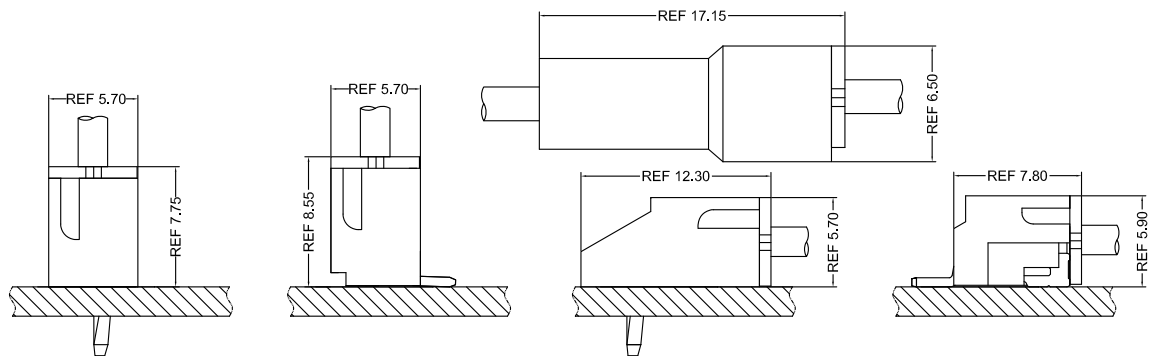

- Note: 1. The above figure is the figure viewed from the connector mounting side.
2. Tolerances are non-cumulative: ± 0.08 mm for all centers.
3. The dimensions above should serve as a guideline. Contact CSG for details.

CSG

Tel: +86-769-85312070 85375507 E-mail: James@csg-china.com www.csg-china.com www.jst-connector.cn

A2501 XH

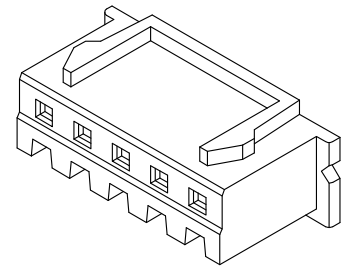
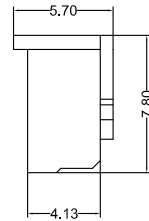
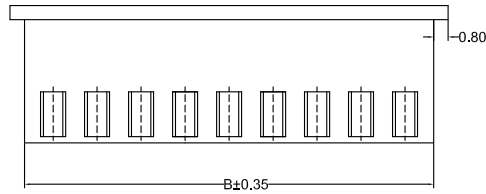
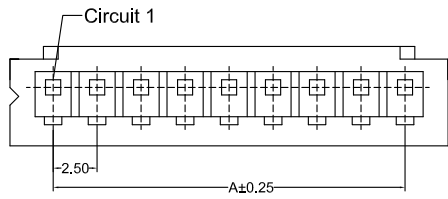

A2501HF 0XX AA P6 9 XXX

PIN
005=5PINS

SPECIAL
AA=NO Special

Material
P6=PA66 94V-0

Code
005
008

Color
9=White

CSG PART NO.	Dimension mm		Qty/BAG
	A	B	
A2501HF002AAP69XXX	2.50	5.50	1000PCS
A2501HF003AAP69XXX	5.00	8.00	1000PCS
A2501HF004AAP69XXX	7.50	10.50	1000PCS
A2501HF005AAP69XXX	10.00	13.00	1000PCS
A2501HF006AAP69XXX	12.50	15.50	1000PCS
A2501HF007AAP69XXX	15.00	18.00	1000PCS
A2501HF008AAP69XXX	17.50	20.50	1000PCS
A2501HF009AAP69XXX	20.00	23.00	1000PCS
A2501HF010AAP69XXX	22.50	25.50	1000PCS
A2501HF011AAP69XXX	25.00	28.00	1000PCS
A2501HF012AAP69XXX	27.50	30.50	1000PCS
A2501HF013AAP69XXX	30.00	33.00	1000PCS
A2501HF014AAP69XXX	32.50	35.50	1000PCS
A2501HF015AAP69XXX	35.00	38.00	1000PCS

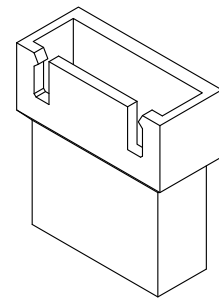
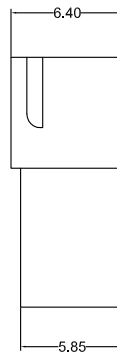
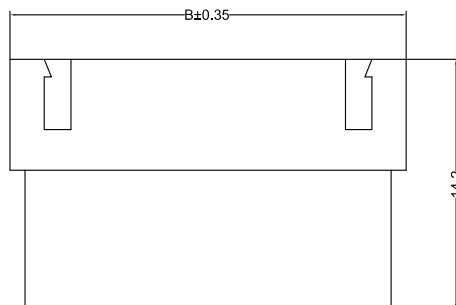

A2501HM 0XX AA P6 9 001

PIN
005=5PINS

SPECIAL
AA=NO Special

Material
P6=PA66 94V-0

Code
001

Color
9=White

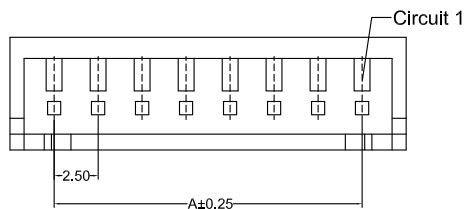

CSG PART NO.	Dimension mm		Qty/BAG
	A	B	
A2501HM002AAP69001	2.50	7.50	1000PCS
A2501HM003AAP69001	5.00	10.00	1000PCS
A2501HM004AAP69001	7.50	12.50	1000PCS
A2501HM005AAP69001	10.00	15.00	1000PCS
A2501HM006AAP69001	12.50	17.50	1000PCS
A2501HM007AAP69001	15.00	20.00	1000PCS
A2501HM008AAP69001	17.50	22.50	1000PCS
A2501HM009AAP69001	20.00	25.00	1000PCS
A2501HM010AAP69001	22.50	27.50	1000PCS
A2501HM011AAP69001	25.00	30.00	1000PCS
A2501HM012AAP69001	27.50	32.50	1000PCS
A2501HM013AAP69001	30.00	35.00	1000PCS
A2501HM014AAP69001	32.50	37.50	1000PCS
A2501HM015AAP69001	35.00	40.00	1000PCS

CSG

A2501 XH

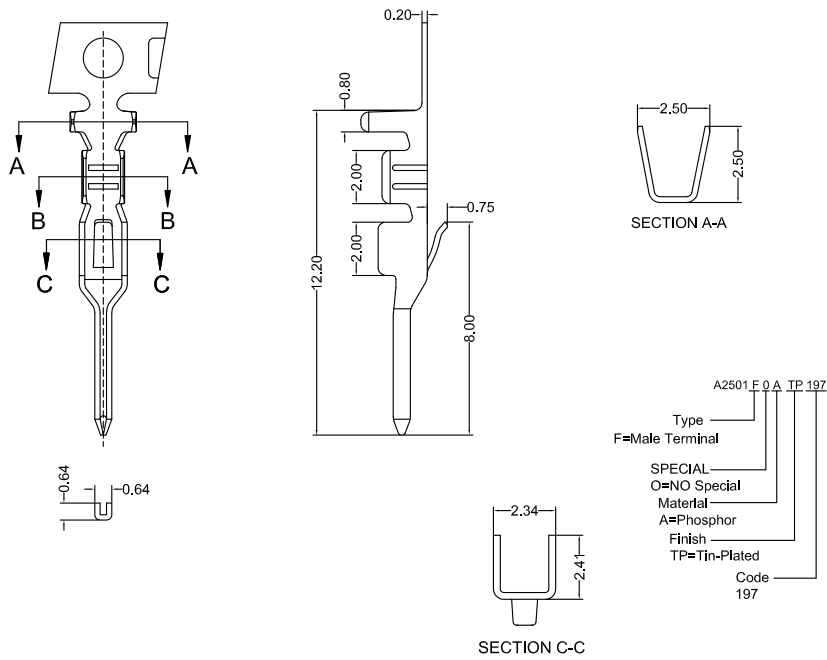

CSG PART NO.	Wire Range	Insulation O.D.	Q'ty/Reel
A2501F0ATP197	AWG#22-#28	1.80mm(max)	8000PCS

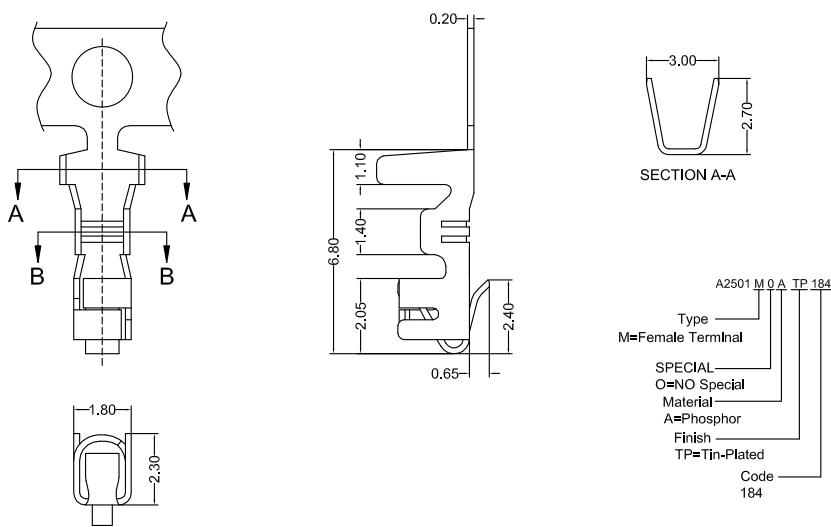

CSG PART NO.	Wire Range	Insulation O.D.	Q'ty/Reel
A2501M0ATP184	AWG#22-#28	1.80mm(max)	8000PCS



A2501 XH

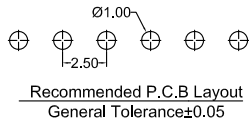
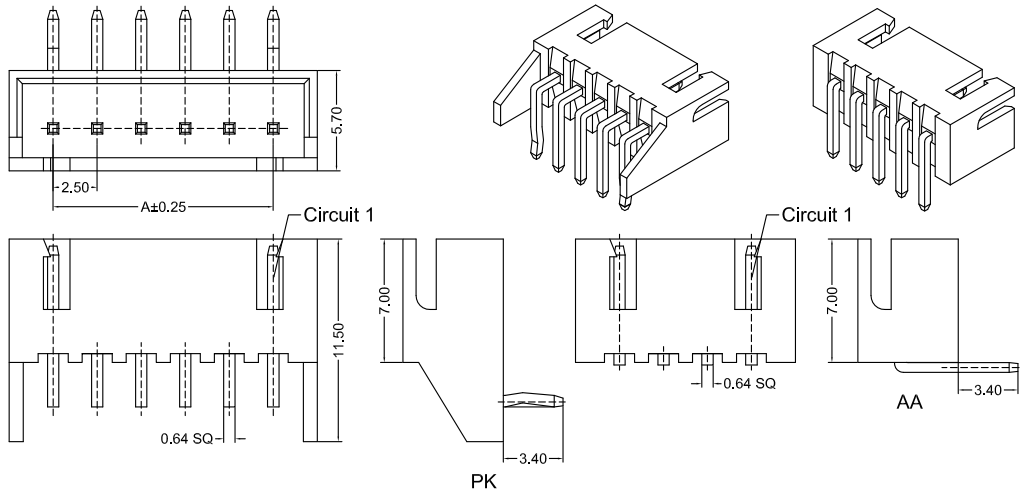

A2501RD.0XX XX P6 TP C 9 008

PIN
002=2PINS

SPECIAL
AA=NO K
PK=Orientation K

Material
P6=PA66 94V-0

Finish
TP=Terminal Tin-Plated

Code
008

Color
9=White

Packing
C=Bag

CSG PART NO.	Dimension mm		Q'ty/BAG
	A	B	
A2501RD002XXP6TPC9008	2.50	7.50	1000PCS
A2501RD003XXP6TPC9008	5.00	10.00	1000PCS
A2501RD004XXP6TPC9008	7.50	12.50	1000PCS
A2501RD005XXP6TPC9008	10.00	15.00	1000PCS
A2501RD006XXP6TPC9008	12.50	17.50	1000PCS
A2501RD007XXP6TPC9008	15.00	20.00	1000PCS
A2501RD008XXP6TPC9008	17.50	22.50	1000PCS
A2501RD009XXP6TPC9008	20.00	25.00	1000PCS
A2501RD010XXP6TPC9008	22.50	27.50	1000PCS
A2501RD011XXP6TPC9008	25.00	30.00	1000PCS
A2501RD012XXP6TPC9008	27.50	32.50	1000PCS
A2501RD013XXP6TPC9008	30.00	35.00	1000PCS
A2501RD014XXP6TPC9008	32.50	37.50	1000PCS
A2501RD015XXP6TPC9008	35.00	40.00	1000PCS

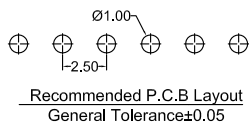
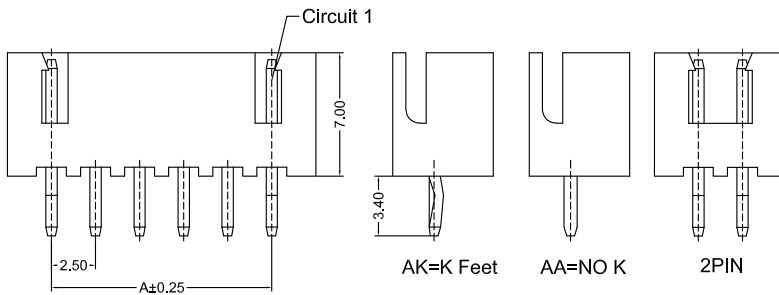
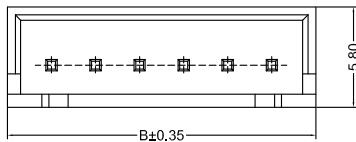

A2501VD.0XX XX P4 X X XXX

PIN
002=2PINS

SPECIAL
AA=NO K
AK=K Feet

Material
P6=PA66 94V-0
P4=PA46 94V-0

Finish
TP=Terminal Tin-Plated
GF=Terminal Gold-Plated

Code
008
001

Color
9=White
8=Grey

Packing
C=Bag

CSG PART NO.	Dimension mm		Q'ty/BAG
	A	B	
A2501VD002XPXXXXXXX	2.50	7.50	1000PCS
A2501VD003XPXXXXXXX	5.00	10.00	1000PCS
A2501VD004XPXXXXXXX	7.50	12.50	1000PCS
A2501VD005XPXXXXXXX	10.00	15.00	1000PCS
A2501VD006XPXXXXXXX	12.50	17.50	1000PCS
A2501VD007XPXXXXXXX	15.00	20.00	1000PCS
A2501VD008XPXXXXXXX	17.50	22.50	1000PCS
A2501VD009XPXXXXXXX	20.00	25.00	1000PCS
A2501VD010XPXXXXXXX	22.50	27.50	1000PCS
A2501VD011XPXXXXXXX	25.00	30.00	1000PCS
A2501VD012XPXXXXXXX	27.50	32.50	1000PCS
A2501VD013XPXXXXXXX	30.00	35.00	1000PCS
A2501VD014XPXXXXXXX	32.50	37.50	1000PCS
A2501VD015XPXXXXXXX	35.00	40.00	1000PCS



A2501 XH

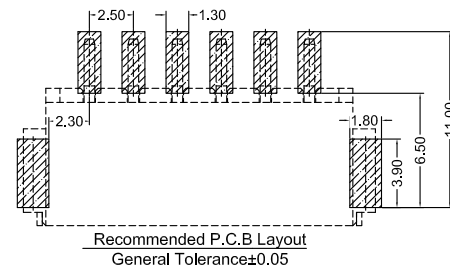
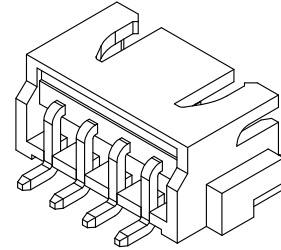
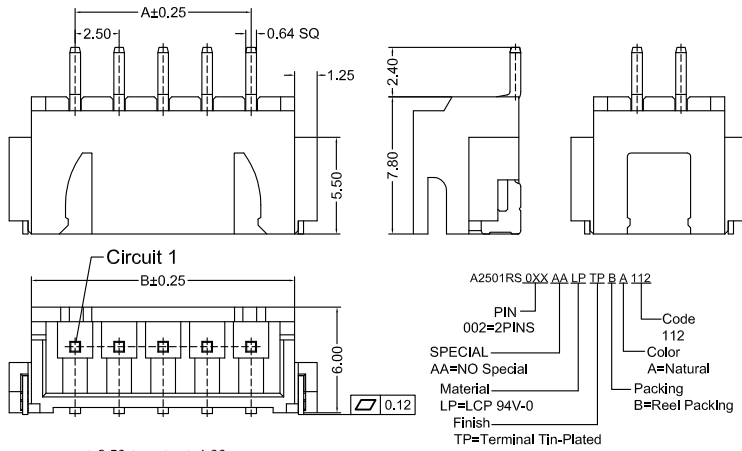

CSG PART NO.	Dimension mm		Q'ty/Reel
	A	B	
A2501RS002AALPTPBA112	2.50	7.50	700PCS
A2501RS003AALPTPBA112	5.00	10.00	700PCS
A2501RS004AALPTPBA112	7.50	12.50	700PCS
A2501RS005AALPTPBA112	10.00	15.00	700PCS
A2501RS006AALPTPBA112	12.50	17.50	700PCS
A2501RS007AALPTPBA112	15.00	20.00	700PCS
A2501RS008AALPTPBA112	17.50	22.50	700PCS
A2501RS009AALPTPBA112	20.00	25.00	700PCS
A2501RS010AALPTPBA112	22.50	27.50	700PCS
A2501RS011AALPTPBA112	25.00	30.00	700PCS
A2501RS012AALPTPBA112	27.50	32.50	700PCS
A2501RS013AALPTPBA112	30.00	35.00	700PCS
A2501RS014AALPTPBA112	32.50	37.50	700PCS
A2501RS015AALPTPBA112	35.00	40.00	700PCS

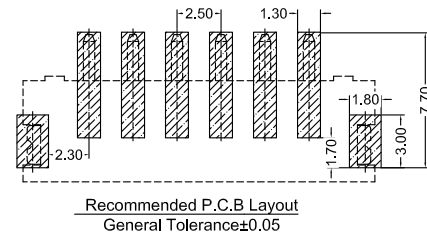
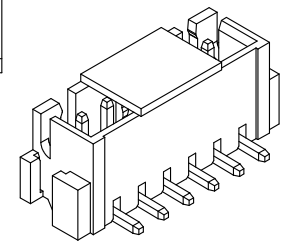
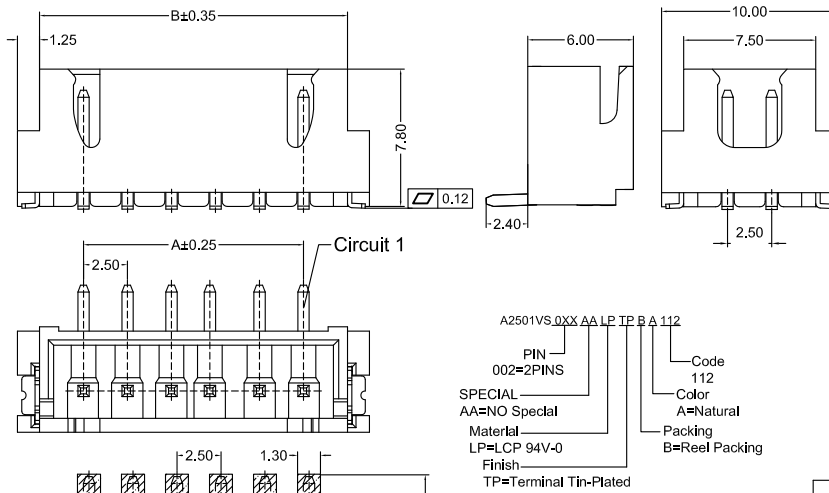

CSG PART NO.	Dimension mm		Q'ty/Reel
	A	B	
A2501VS002AALPTPBA112	2.50	7.50	500PCS
A2501VS003AALPTPBA112	5.00	10.00	500PCS
A2501VS004AALPTPBA112	7.50	12.50	500PCS
A2501VS005AALPTPBA112	10.00	15.00	500PCS
A2501VS006AALPTPBA112	12.50	17.50	500PCS
A2501VS007AALPTPBA112	15.00	20.00	500PCS
A2501VS008AALPTPBA112	17.50	22.50	500PCS
A2501VS009AALPTPBA112	20.00	25.00	500PCS
A2501VS010AALPTPBA112	22.50	27.50	500PCS
A2501VS011AALPTPBA112	25.00	30.00	500PCS
A2501VS012AALPTPBA112	27.50	32.50	500PCS
A2501VS013AALPTPBA112	30.00	35.00	500PCS
A2501VS014AALPTPBA112	32.50	37.50	500PCS
A2501VS015AALPTPBA112	35.00	40.00	500PCS



A2501 XH

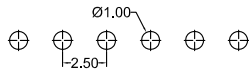
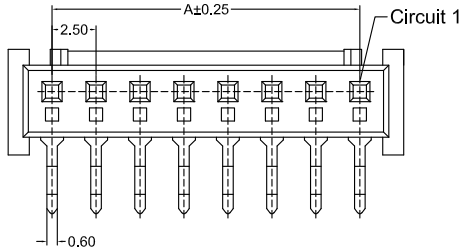
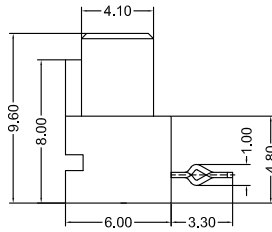
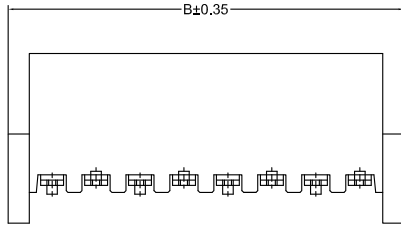

Recommended P.C.B Layout
General Tolerance±0.05

A2501RD_0XX BB P6 TP C 9 209
 PIN 002=2PINS Code 209
 SPECIAL Color 9=White
 BB=B TO B Packing C=Bag
 Material P6=PA66 94V-0
 Finish TP=Terminal Tin-Plated

CSG PART NO.	Dimension mm		Q'ty/BAG
	A	B	
A2501RD002BBP6TPC9209	2.50	7.50	1000PCS
A2501RD003BBP6TPC9209	5.00	10.00	1000PCS
A2501RD004BBP6TPC9209	7.50	12.50	1000PCS
A2501RD005BBP6TPC9209	10.00	15.00	1000PCS
A2501RD006BBP6TPC9209	12.50	17.50	1000PCS
A2501RD007BBP6TPC9209	15.00	20.00	1000PCS
A2501RD008BBP6TPC9209	17.50	22.50	1000PCS
A2501RD009BBP6TPC9209	20.00	25.00	1000PCS
A2501RD010BBP6TPC9209	22.50	27.50	1000PCS
A2501RD011BBP6TPC9209	25.00	30.00	1000PCS
A2501RD012BBP6TPC9209	27.50	32.50	1000PCS
A2501RD015BBP6TPC9209	35.00	40.00	1000PCS

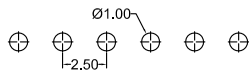
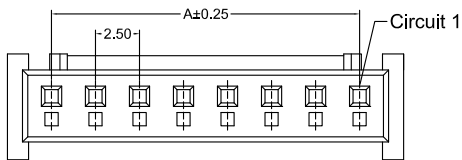
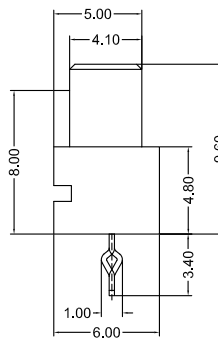
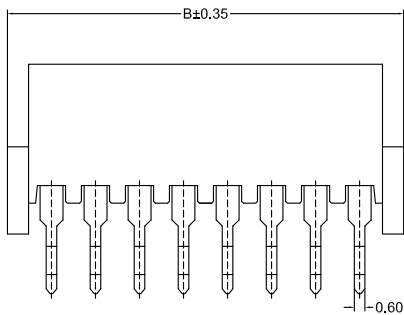

Recommended P.C.B Layout
General Tolerance±0.05

A2501VD_0XX BB P6 TP C 9 209
 PIN 002=2PINS Code 209
 SPECIAL Color 9=White
 BB=B TO B Packing C=Bag
 Material P6=PA66 94V-0
 Finish TP=Terminal Tin-Plated

CSG PART NO.	Dimension mm		Q'ty/BAG
	A	B	
A2501VD002BBP6TPC9209	2.50	7.50	1000PCS
A2501VD003BBP6TPC9209	5.00	10.00	1000PCS
A2501VD004BBP6TPC9209	7.50	12.50	1000PCS
A2501VD005BBP6TPC9209	10.00	15.00	1000PCS
A2501VD006BBP6TPC9209	12.50	17.50	1000PCS
A2501VD007BBP6TPC9209	15.00	20.00	1000PCS
A2501VD008BBP6TPC9209	17.50	22.50	1000PCS
A2501VD009BBP6TPC9209	20.00	25.00	1000PCS
A2501VD010BBP6TPC9209	22.50	27.50	1000PCS
A2501VD011BBP6TPC9209	25.00	30.00	1000PCS
A2501VD012BBP6TPC9209	27.50	32.50	1000PCS
A2501VD020BBP6TPC9209	47.50	52.50	1000PCS

