

A1008 SHL/SHLD CONNECTOR

1.00mm Pitch/Disconnectable Crimp style connectors

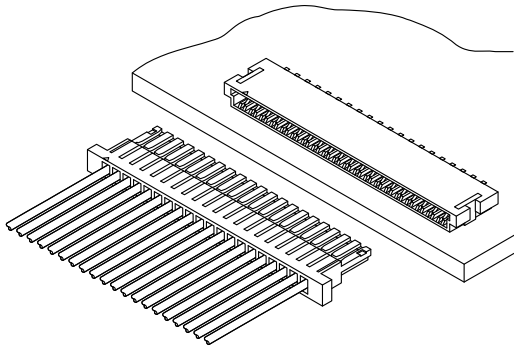

As the equipment becomes thinner and thinner, this is an ultra-thin connector with a mounting height of 1.8mm, which was developed as a variation of our 1.0 mm pitch connectors.

- Thin design
- Low insertion force
- Prevention of deformation

 E529482

Specifications:

- Current rating: 1.0 A AC,DC
- Voltage rating: 50 V AC/DC
- Temperature range: -40°C ~ +105°C
(including temperature rise in applying electrical current)
- Contact resistance: Initial value/ 20m Ω max
After environmental testing/ 40m Ω max
- Insulation resistance: 100 M Ω min
- Withstanding voltage: 500 VAC/minute
- Applicable wire: Conductor size/ AWG#32 to #28

- * Compliant with RoHS2/ REACH
- * In using the products, refer to "Handling Precautions for Terminals and Connectors" described on our website (Technical documents of Product information page).
- * Contact CSG for details

Material:

Housing: PA66,UL94-V0;Color:White
Terminal: Phosphor/ Tin-plated, Gold-Plated
Wafer Housing: PA6T,UL94-V0;Color:Natural
Wafer Pin: Phosphor/ Tin-plated
Wafer Fixed Foot: Bass/ Tin-plated

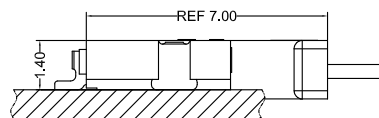
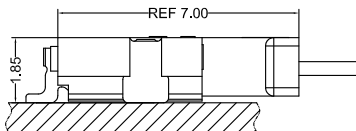

- Note: 1. The above figure is the figure viewed from the connector mounting side.
2. Tolerances are non-cumulative: ± 0.08 mm for all centers.
3. The dimensions above should serve as a guideline. Contact CSG for details.

CSG

Tel: +86-769-85312070 85375507 E-mail: James@csg-china.com www.csg-china.com www.jst-connector.cn

A1008 SHL/SHLD CONNECTOR

1.00mm Pitch/Disconnectable Crimp style connectors

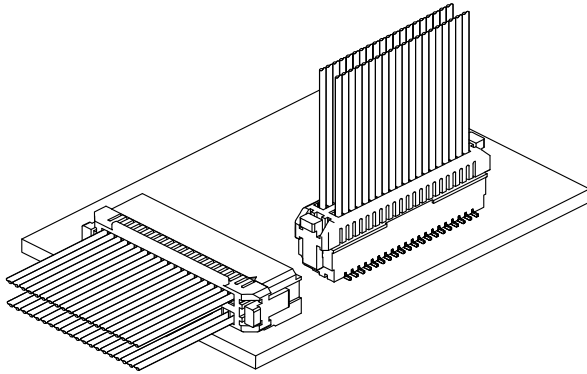

Developed for PDP, LCD or small electronics equipment.

This is a dual-row small crimp type connector with a secure locking system or without-designed for different applications. The PC board layout is compatible with that of existing SHD connector, which allows for replacement of the above existing connector.

- Secure housing lock structure (for locking type)
- Prevent deformation of contacts
- A contact lock structure
- Strong structure against external force



Specifications:

- Current rating: 1.0 A AC,DC
- Voltage rating: 50 V AC/DC
- Temperature range: $-25^{\circ}\text{C} \sim +105^{\circ}\text{C}$
(including temperature rise in applying electrical current)
- Contact resistance: Initial value/ 20m Ω max
After environmental testing/ 40m Ω max
- Insulation resistance: 100 M Ω min
- Withstanding voltage: 500 VAC/minute
- Applicable wire: Conductor size/ AWG#32 to #28

- * Compliant with RoHS2/ REACH
- * In using the products, refer to "Handling Precautions for Terminals and Connectors" described on our website (Technical documents of Product information page).
- * Contact CSG for details

Material:

Housing: PA66,UL94-V0;Color:White
Terminal: Phosphor/ Tin-plated, Gold-Plated
Wafer Housing: LCP/ 9T,UL94-V0;Color:Natural
Wafer Pin: Phosphor/ Gold-Plated
Wafer Fixed Foot: Bass/ Tin-plated

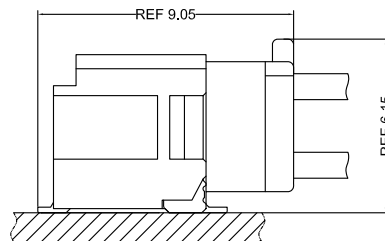
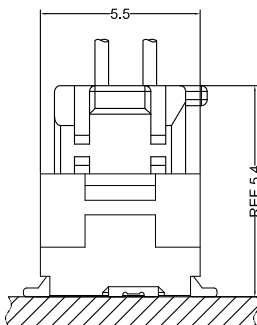

- Note: 1. The above figure is the figure viewed from the connector mounting side.
2. Tolerances are non-cumulative: ± 0.08 mm for all centers.
3. The dimensions above should serve as a guideline. Contact CSG for details.

CSG

Tel: +86-769-85312070 85375507 E-mail: James@csg-china.com www.csg-china.com www.jst-connector.cn

A1008 SHL/SHLD

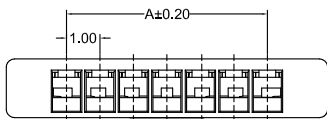
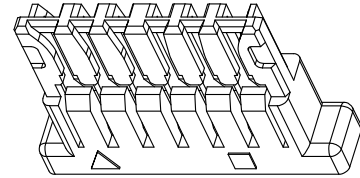
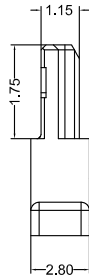
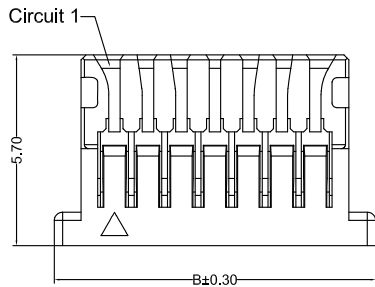

A1008HF 0XX AA P6 9 001
 PIN 002=2PINS
 SPECIAL AA=NO Special
 Material P6=PA66 94V-0
 Code 001
 Color 9=White

CSG PART NO.	Dimension mm		Q'ty/BAG
	A	B	
A1008HF002AAP69001	1.00	4.60	1000PCS
A1008HF005AAP69001	4.00	7.60	1000PCS
A1008HF006AAP69001	5.00	8.60	1000PCS
A1008HF007AAP69001	6.00	9.60	1000PCS
A1008HF008AAP69001	7.00	10.60	1000PCS
A1008HF010AAP69001	9.00	12.60	1000PCS
A1008HF011AAP69001	10.00	13.60	1000PCS
A1008HF012AAP69001	11.00	14.60	1000PCS
A1008HF014AAP69001	13.00	16.60	1000PCS
A1008HF016AAP69001	15.00	18.60	1000PCS
A1008HF020AAP69001	19.00	22.60	1000PCS
A1008HF022AAP69001	21.00	24.60	1000PCS
A1008HF026AAP69001	25.00	28.60	1000PCS
A1008HF030AAP69001	29.00	32.60	1000PCS

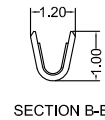
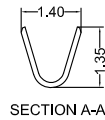
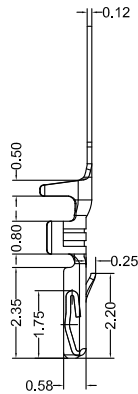
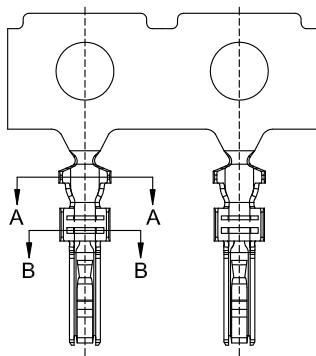

A1008 M 0 A XX 001
 Type M=Female Terminal
 Material A=Phosphor
 Finish TP=Tin-Plated GF=Gold-Plated
 Code 001

CSG PART NO.	Wire Range	Insulation O.D.	Q'ty/Reel
A1008M0ATP001	AWG#28-#32	0.75mm(max)	20000PCS
A1008M0AGF001	AWG#28-#32	0.75mm(max)	20000PCS



A1008 SHL/SHLD

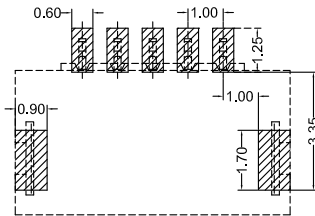
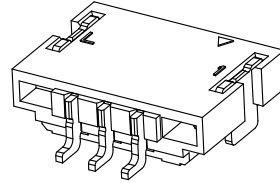
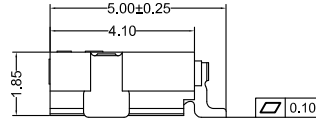
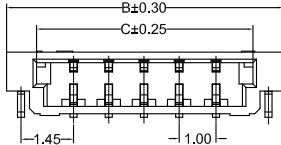
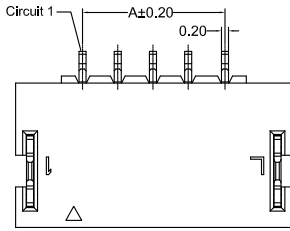

Recommended P.C.B Layout
General Tolerance±0.05

A1008RS_0XX AA 6T TP B A 112

PIN
002=2PINS
SPECIAL
AA=NO Special
Material
6T=PA6T 94V-0
Finish
TP=Terminal Tin-Plated

Code
112
Color
A=Natural
Packing
B=Tape & Reel

CSG PART NO.	Dimension mm			Q'ty/Reel
	A	B	C	
A1008RS002AA6TTPBA112	1.00	4.80	3.10	4000PCS
A1008RS003AA6TTPBA112	2.00	5.80	4.10	4000PCS
A1008RS004AA6TTPBA112	3.00	6.80	5.10	4000PCS
A1008RS005AA6TTPBA112	4.00	7.80	6.10	4000PCS
A1008RS006AA6TTPBA112	5.00	8.80	7.10	4000PCS
A1008RS007AA6TTPBA112	6.00	9.80	8.10	4000PCS
A1008RS008AA6TTPBA112	7.00	10.80	9.10	4000PCS
A1008RS010AA6TTPBA112	9.00	12.80	11.10	4000PCS
A1008RS012AA6TTPBA112	11.00	14.80	13.10	4000PCS

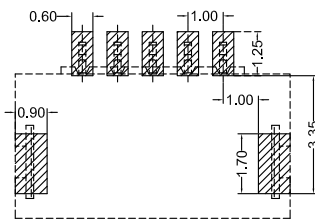
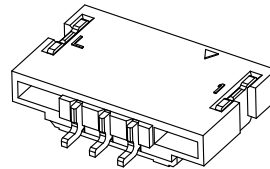
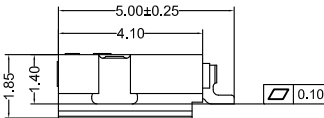
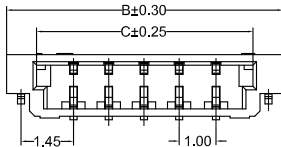
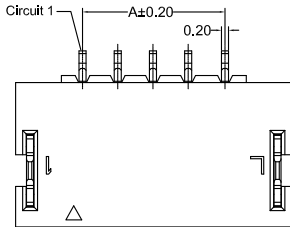

Recommended P.C.B Layout
General Tolerance±0.05

A1008RS_0XX CB 6T TP B A 112

PIN
002=2PINS
SPECIAL
CB=Sunken plate
Material
6T=PA6T 94V-0
Finish
TP=Terminal Tin-Plated

Code
112
Color
A=Natural
Packing
B=Tape & Reel

CSG PART NO.	Dimension mm			Q'ty/Reel
	A	B	C	
A1008RS002CB6TTPBA112	1.00	4.80	3.10	4000PCS
A1008RS003CB6TTPBA112	2.00	5.80	4.10	4000PCS
A1008RS004CB6TTPBA112	3.00	6.80	5.10	4000PCS
A1008RS005CB6TTPBA112	4.00	7.80	6.10	4000PCS
A1008RS006CB6TTPBA112	5.00	8.80	7.10	4000PCS
A1008RS007CB6TTPBA112	6.00	9.80	8.10	4000PCS
A1008RS008CB6TTPBA112	7.00	10.80	9.10	4000PCS



A1008 SHL/SHLD

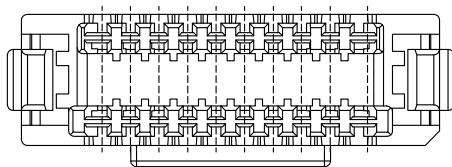
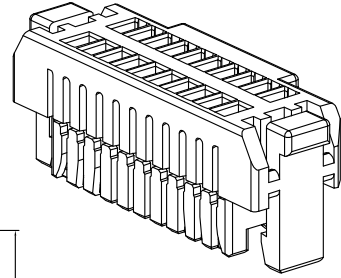
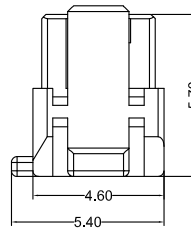
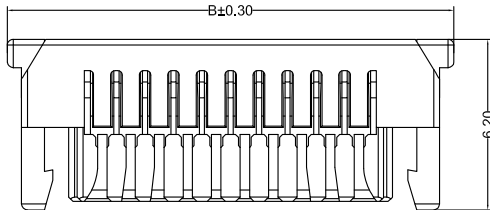
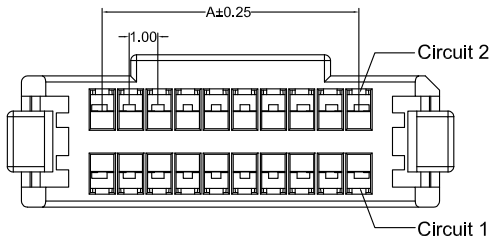

A1008HF 2XX AK P6 9 001
 PIN
 204=2X4PINS
 SPECIAL
 AK=BUCKLE
 Material
 P6=PA66 94V-0
 Code
 001
 Color
 9=White

CSG PART NO.	Dimension mm		Q'ty/BAG
	A	B	
A1008HF204AKP69001	3.00	9.70	1000PCS
A1008HF205AKP69001	4.00	10.70	1000PCS
A1008HF206AKP69001	5.00	11.70	1000PCS
A1008HF207AKP69001	6.00	12.70	1000PCS
A1008HF208AKP69001	7.00	13.70	1000PCS
A1008HF210AKP69001	9.00	15.70	1000PCS
A1008HF212AKP69001	11.00	17.70	1000PCS
A1008HF215AKP69001	14.00	20.70	1000PCS
A1008HF220AKP69001	19.00	25.70	1000PCS
A1008HF225AKP69001	24.00	30.70	1000PCS

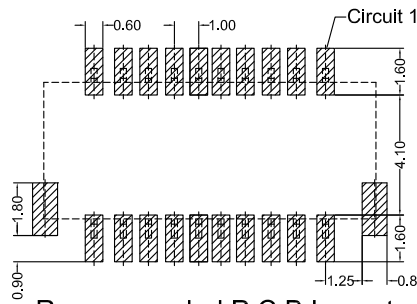
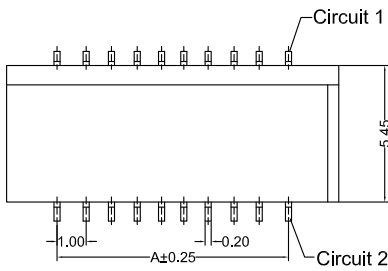

Recommended P.C.B Layout
 General Tolerance±0.05

A1008RS 0XX AA LP TP B A 001
 PIN
 002=2PINS
 SPECIAL
 AA=NO Special
 Material
 LP=LCP 94V-0
 Finish
 GF=Terminal Gold-Plated
 Code
 001
 Color
 A=Natural
 Packing
 B=Reel

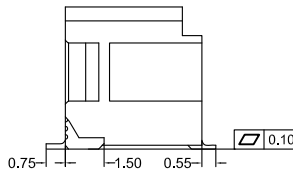
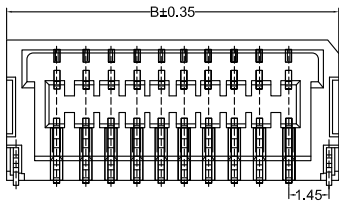

CSG PART NO.	Dimension mm		Q'ty/Reel
	A	B	
A1008RS205AALPGFBA001	4.00	8.00	1000PCS
A1008RS206AALPGFBA001	5.00	9.00	1000PCS
A1008RS207AALPGFBA001	6.00	10.00	1000PCS
A1008RS208AALPGFBA001	7.00	11.00	1000PCS
A1008RS210AALPGFBA001	9.00	13.00	1000PCS
A1008RS212AALPGFBA001	11.00	15.00	1000PCS
A1008RS215AALPGFBA001	14.00	18.00	1000PCS
A1008RS220AALPGFBA001	19.00	23.00	1000PCS
A1008RS225AALPGFBA001	24.00	28.00	1000PCS



A1008 SHL/SHLD

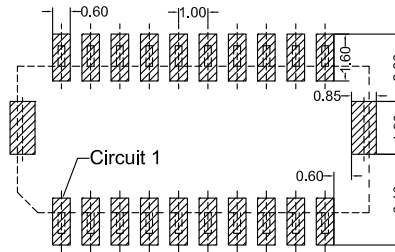
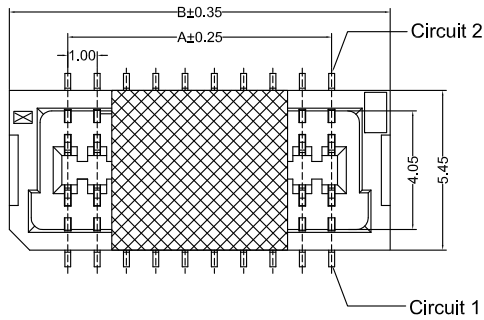

Recommended P.C.B Layout
General Tolerance±0.05

A1008VS_0XX AA 9T TP B A 195
 PIN
 002=2PINS
 SPECIAL
 AA=NO Special
 Material
 9T=PA9T 94V-0
 Finish
 GF=Terminal Gold-Plated
 Code
 195
 Color
 A=Natural
 Packing
 B=Reel

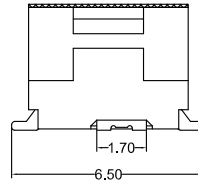
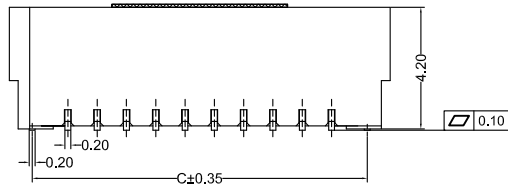

CSG PART NO.	Dimension mm			Qty/Reel
	A	B	C	
A1008VS205AA9TGFBA195	4.00	8.00	6.43	1000PCS
A1008VS206AA9TGFBA195	5.00	9.00	7.43	1000PCS
A1008VS207AA9TGFBA195	6.00	10.00	8.43	1000PCS
A1008VS208AA9TGFBA195	7.00	11.00	8.43	1000PCS
A1008VS210AA9TGFBA195	9.00	13.00	11.43	1000PCS
A1008VS212AA9TGFBA195	11.00	15.00	13.43	1000PCS
A1008VS215AA9TGFBA195	14.00	18.00	16.43	1000PCS
A1008VS220AA9TGFBA195	19.00	23.00	21.43	1000PCS
A1008VS225AA9TGFBA195	24.00	28.00	26.43	1000PCS

CSG