

A1009 501330 CONNECTOR

1.00mm Pitch/Disconnectable Crimp style connectors

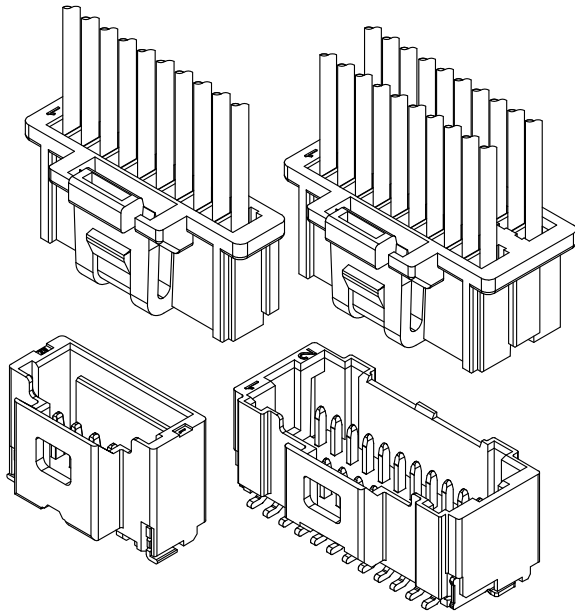

 E529482

Specifications:

- Current rating: 1.0 A AC,DC
- Voltage rating: 100 V AC/DC
- Temperature range: $-25^{\circ}\text{C} \sim +105^{\circ}\text{C}$
(including temperature rise in applying electrical current)
- Contact resistance: Initial value/ 30m Ω max
After environmental testing/ 40m Ω max
- Insulation resistance: 500 M Ω min
- Withstanding voltage: 500 VAC/minute
- Applicable wire: Conductor size/ AWG#32 to #28

- * Compliant with RoHS2/ REACH/ HF
- * In using the products, refer to "Handling Precautions for Terminals and Connectors" described on our website (Technical documents of Product information page).
- * Contact CSG for details

Material:

Housing: PA66,UL94-V0;Color:White
Terminal: Phosphor/ Tin-plated, Gold-Plated
Wafer Housing: LCP/ 4T/ 9T,UL94-V0;Color:Natural/ Black
Wafer Pin: Phosphor/ Tin-plated
Wafer Fixed Foot: Bass/ Tin-plated

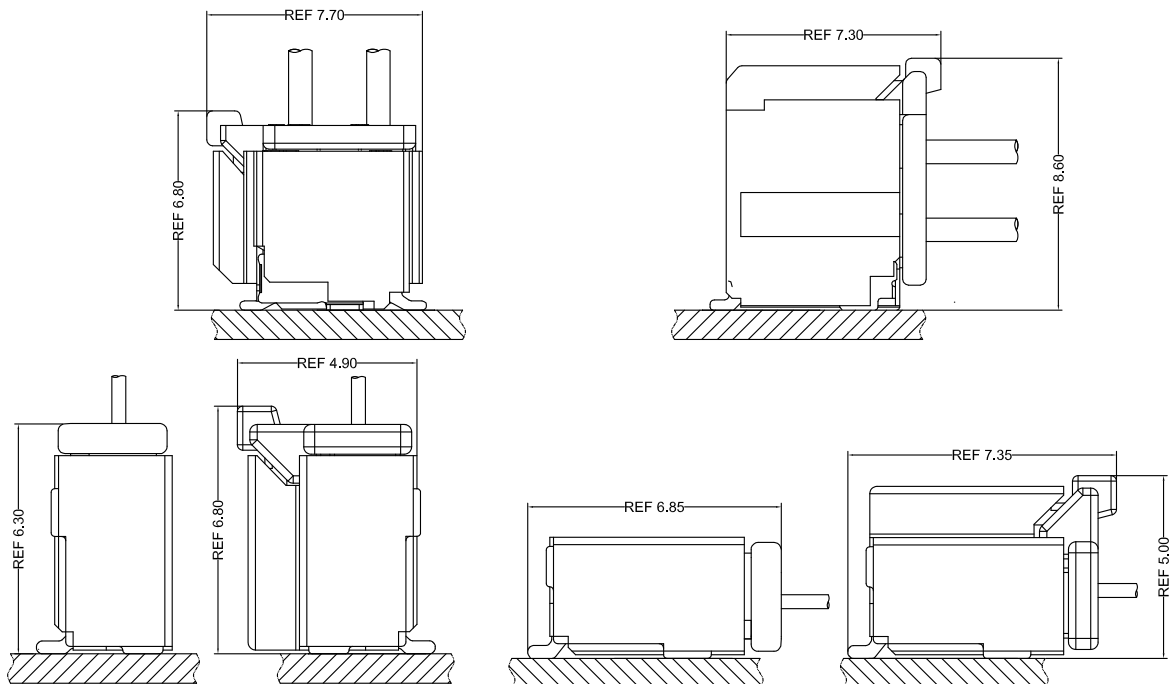

- Note: 1. The above figure is the figure viewed from the connector mounting side.
2. Tolerances are non-cumulative: ± 0.08 mm for all centers.
3. The dimensions above should serve as a guideline. Contact CSG for details.

CSG

Tel:+86-769-85312070 85375507 E-mail:James@csg-china.com www.csg-china.com www.jst-connector.cn

A1009 501330

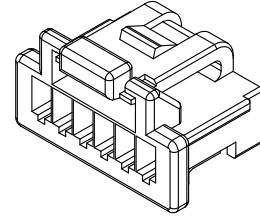
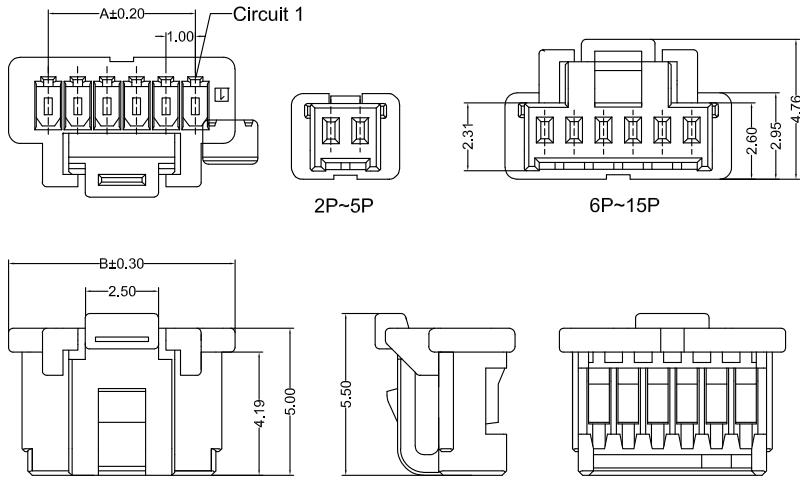

A1009HF 0XX AA P6 9 006
 PIN
 002=2PINS
 SPECIAL
 AA=NO Protrusions
 AK=BUCKLE
 Material
 P6=PA66 94V-0
 Code
 006
 Color
 9=White

CSG PART NO.	Dimension mm		Q'ty/BAG
	A	B	
A1009HF002AAP69006	1.00	3.70	1000PCS
A1009HF003AAP69006	2.00	4.70	1000PCS
A1009HF004AAP69006	3.00	5.70	1000PCS
A1009HF005AAP69006	4.00	6.70	1000PCS
A1009HF006AKP69006	5.00	7.70	1000PCS
A1009HF007AKP69006	6.00	8.70	1000PCS
A1009HF008AKP69006	7.00	9.70	1000PCS
A1009HF009AKP69006	8.00	10.70	1000PCS
A1009HF010AKP69006	9.00	11.70	1000PCS
A1009HF011AKP69006	10.00	12.70	1000PCS
A1009HF012AKP69006	11.00	13.70	1000PCS
A1009HF013AKP69006	12.00	14.70	1000PCS
A1009HF014AKP69006	13.00	15.70	1000PCS
A1009HF015AKP69006	14.00	16.70	1000PCS

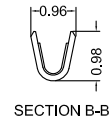
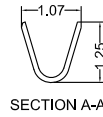
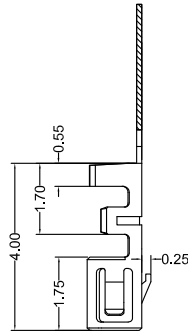
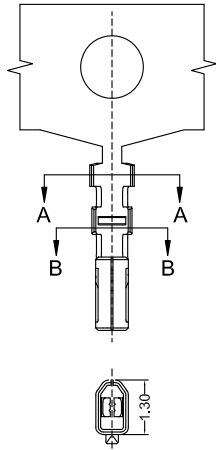

A1009 M 0 A XX 006
 Type
 M=Female Terminal
 Material
 A=Phosphor
 Finish
 TP=Tin-Plated
 GF=Gold-Plated
 Code
 006

CSG PART NO.	Wire Range	Insulation O.D.	Q'ty/Reel
A1009M0ATP006	AWG#28-#32	0.75mm(max)	20000PCS
A1009M0AGF006	AWG#28-#32	0.75mm(max)	20000PCS

CSG

A1009 501330

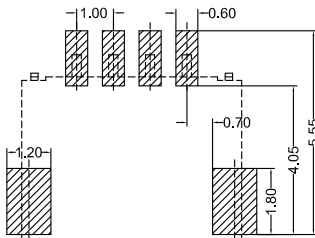
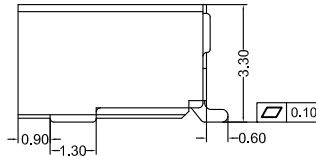
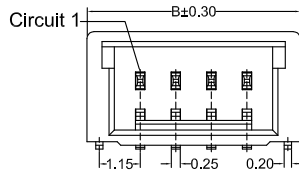
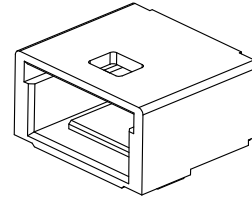
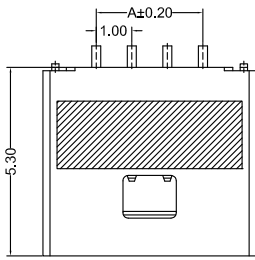

A1009RS_0XX AA LP TP B A 001

- PIN
- 002=2PINS
- SPECIAL
- AA=NO Special
- Material
- LP=LCP 94V-0
- Finish
- TP=Terminal Tin-Plated
- Code
- 001
- Color
- A=Natural
- Packing
- B=Tape & Reel

Recommended P.C.B Layout
General Tolerance±0.05

CSG PART NO.	Dimension mm		Q'ty/Reel
	A	B	
A1009RS002AALPTPBA001	1.00	4.00	1000PCS
A1009RS003AALPTPBA001	2.00	5.00	1000PCS
A1009RS004AALPTPBA001	3.00	6.00	1000PCS
A1009RS005AALPTPBA001	4.00	7.00	1000PCS

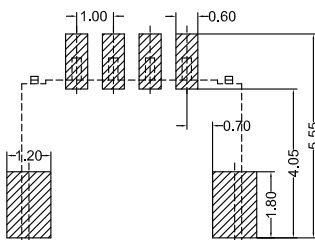
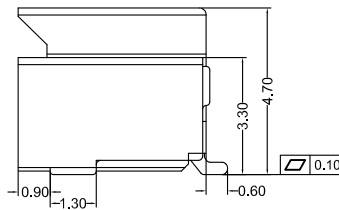
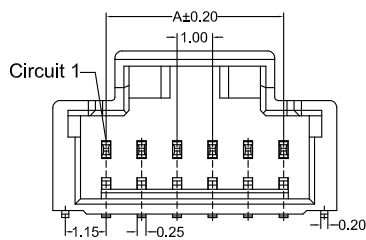
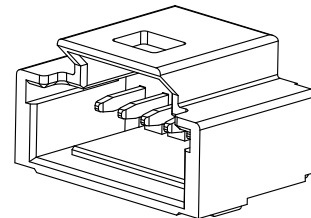
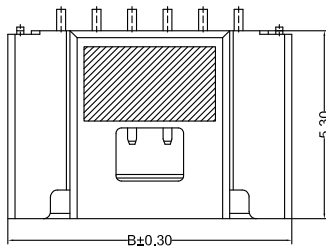

A1009RS_0XX AA 4T XX B A 001

- PIN
- 002=2PINS
- SPECIAL
- AA=NO Special
- Material
- 4T=PA4T 94V-0
- Finish
- TP=Terminal Tin-Plated
- GF=Terminal Gold-Plated
- Code
- 001
- Color
- A=Natural
- Packing
- B=Tape & Reel

Recommended P.C.B Layout
General Tolerance±0.05

CSG PART NO.	Dimension mm		Q'ty/Reel
	A	B	
A1009RS006AA4TXXBA001	5.00	8.00	1000PCS
A1009RS007AA4TXXBA001	6.00	9.00	1000PCS
A1009RS008AA4TXXBA001	7.00	10.00	1000PCS
A1009RS009AA4TXXBA001	8.00	11.00	1000PCS
A1009RS010AA4TXXBA001	9.00	12.00	1000PCS
A1009RS011AA4TXXBA001	10.00	13.00	1000PCS
A1009RS012AA4TXXBA001	11.00	14.00	1000PCS
A1009RS013AA4TXXBA001	12.00	15.00	1000PCS
A1009RS014AA4TXXBA001	13.00	16.00	1000PCS
A1009RS015AA4TXXBA001	14.00	17.00	1000PCS



A1009 501330

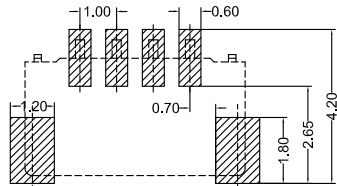
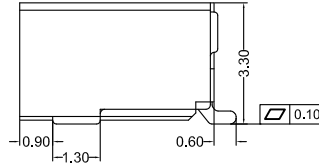
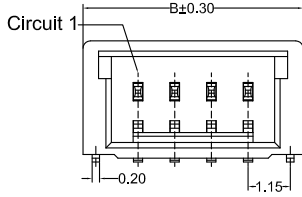
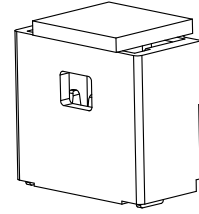
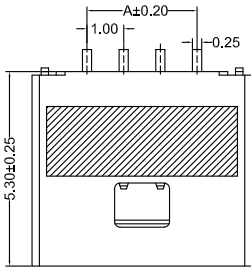

A1009RS_0XX AA LP TP BA 001

- PIN
- 002=2PINS
- SPECIAL
- AA=NO Special
- Material
- LP=LCP 94V-0
- Finish
- TP=Terminal Tin-Plated
- Code
- 001
- Color
- A=Natural
- Packing
- B=Tape & Reel

CSG PART NO.	Dimension mm		Q'ty/Reel
	A	B	
A1009VS002AALPTPBA001	1.00	4.00	800PCS
A1009VS003AALPTPBA001	2.00	5.00	800PCS
A1009VS004AALPTPBA001	3.00	6.00	800PCS
A1009VS005AALPTPBA001	4.00	7.00	800PCS

Recommended P.C.B Layout
General Tolerance±0.05

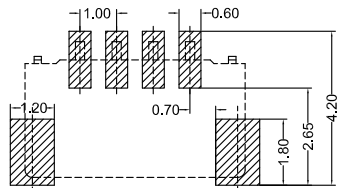
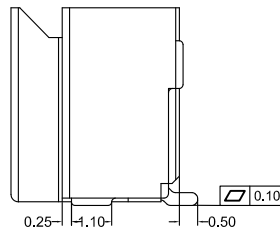
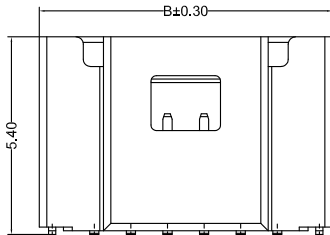
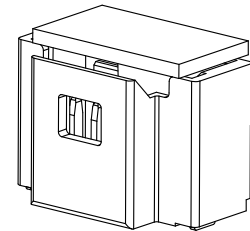
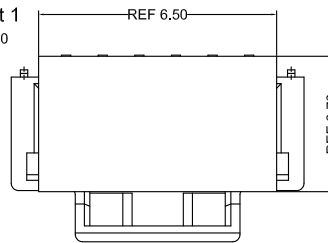
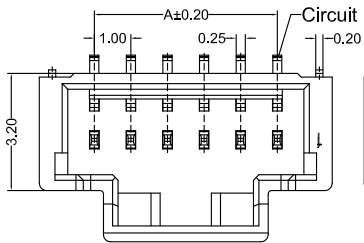

A1009VS_0XX AA 4T XX BA 001

- PIN
- 002=2PINS
- SPECIAL
- AA=NO Special
- Material
- 4T=PA4T 94V-0
- Finish
- TP=Terminal Tin-Plated
- GF=Terminal Gold-Plated
- Code
- 001
- Color
- A=Natural
- Packing
- B=Tape & Reel

CSG PART NO.	Dimension mm		Q'ty/Reel
	A	B	
A1009VS006AA4TXXBA001	5.00	8.00	800PCS
A1009VS007AA4TXXBA001	6.00	9.00	800PCS
A1009VS008AA4TXXBA001	7.00	10.00	800PCS
A1009VS009AA4TXXBA001	8.00	11.00	800PCS
A1009VS010AA4TXXBA001	9.00	12.00	800PCS
A1009VS011AA4TXXBA001	10.00	13.00	800PCS
A1009VS012AALPTPBA001	11.00	14.00	800PCS
A1009VS013AA4TXXBA001	12.00	15.00	800PCS
A1009VS014AA4TXXBA001	13.00	16.00	800PCS
A1009VS015AA4TXXBA001	14.00	17.00	800PCS

Recommended P.C.B Layout
General Tolerance±0.05



A1009 501330

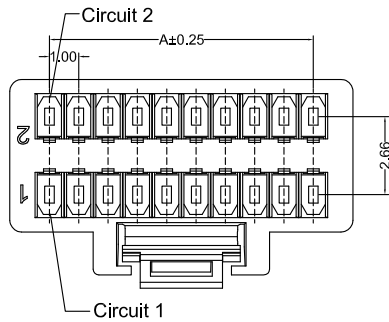

A1009HF 2XX AK P6 9 001
 PIN 210=2X10PINS
 SPECIAL AK=BUCKLE
 Material P6=PA66 94V-0
 Code 001
 Color 9=White

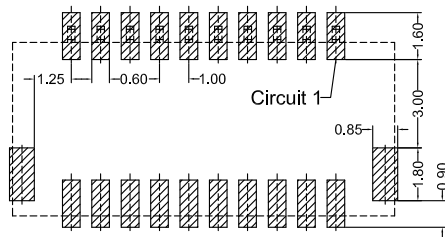
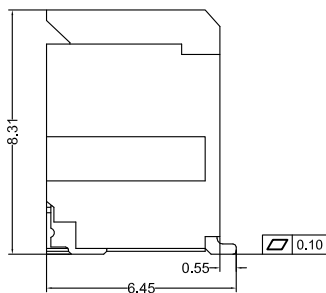
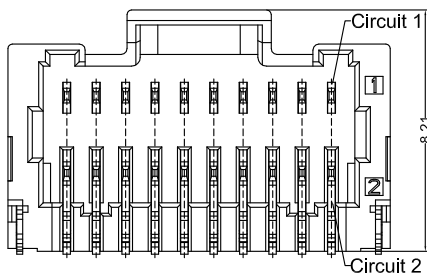
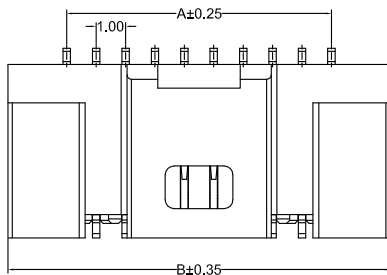
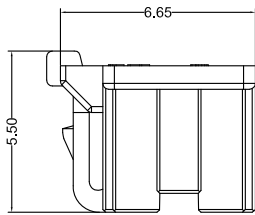
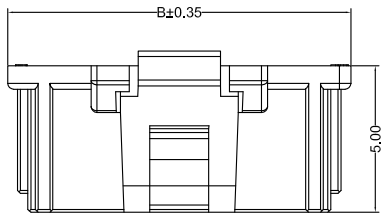
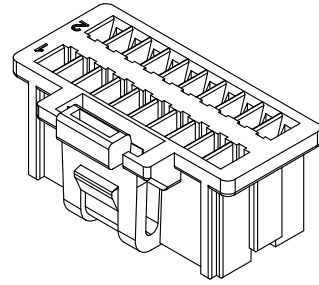

Recommended P.C.B Layout
 General Tolerance±0.05

A1009RS 2XX AA 4T XX B X 001
 PIN 210=2X10PINS
 SPECIAL AA=NO Special
 Material 4T=PA4T 94V-0
 Finish GF=Terminal Gold-Plated
 TP=Terminal Tin-Plated
 Code 001
 Color A=Natural
 0=Black
 Packing B=Tape & Reel

CSG PART NO.	Dimension mm		Q'ty/BAG
	A	B	
A1009HF210AKP69001	9.00	11.70	1000PCS
A1009HF215AKP69001	14.00	16.70	1000PCS
A1009HF220AKP69001	19.00	21.70	1000PCS
A1009HF225AKP69001	24.00	26.70	1000PCS

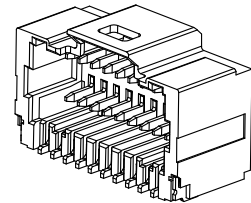

CSG PART NO.	Dimension mm		Q'ty/BAG
	A	B	
A1009RS210AA4TXXBX001	9.00	12.30	400PCS
A1009RS215AA4TXXBX001	14.00	17.30	400PCS
A1009RS220AA4TXXBX001	19.00	22.30	400PCS
A1009RS215AA4TXXBX001	24.00	27.30	400PCS



A1009 501330

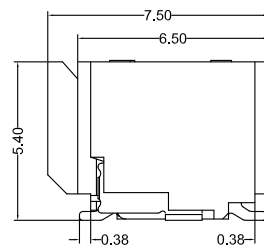
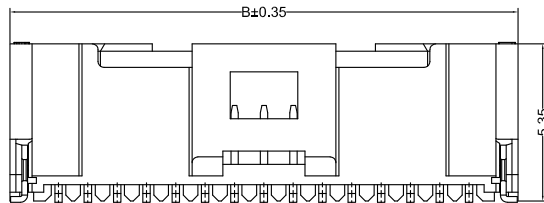
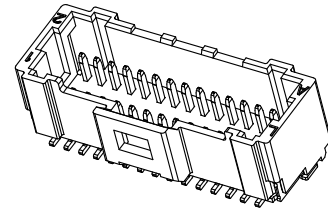
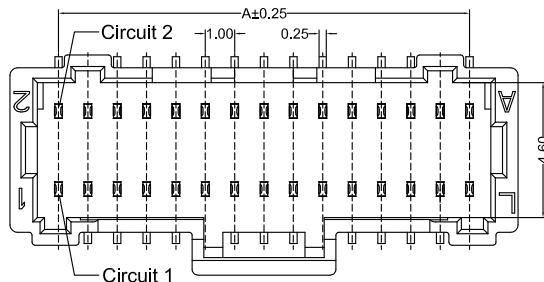

A1009VS2XX AA 9T GF BA 112

- PIN 210=2X10PINS
- SPECIAL AA=NO Special
- Material 9T=PAST 94V-0
- Finish GF=Terminal Gold-Plated
- Code 112
- Color A=Natural
- Packing B=Tape & Reel

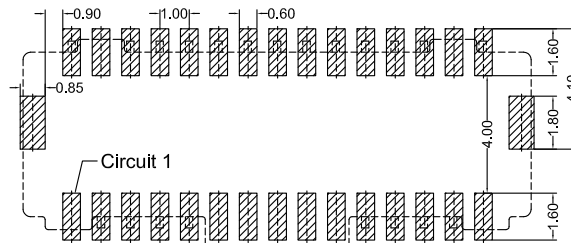

Recommended P.C.B Layout
General Tolerance±0.05

CSG PART NO.	Dimension mm		Q'ty/BAG
	A	B	
A1009VS210AA9TGFB112	9.00	12.30	800PCS
A1009VS215AA9TGFB112	14.00	17.30	800PCS
A1009VS220AA9TGFB112	19.00	22.30	800PCS
A1009VS225AA9TGFB112	24.00	27.30	800PCS

