

# A2543 DU Box CONNECTOR

2.54mm Pitch/Disconnectable Crimp style connectors

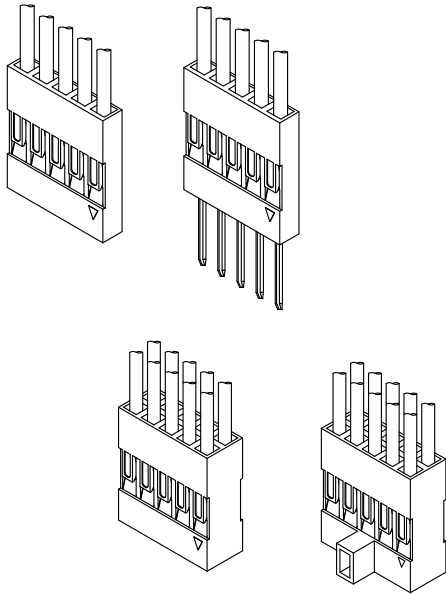

- Secure locking structure
- Low insertion force
- Suction area for picking up
- Improvement of engagement with prying

## Specifications:

- Current rating: 3.0 A / AC,DC (AWG #22)
- Voltage rating: 250 V AC/DC
- Temperature range: -40°C~+105°C  
(including temperature rise in applying electrical current)
- Contact resistance: Initial value/ 20m $\Omega$  max  
Insulation resistance: 1000 M $\Omega$  min  
Withstanding voltage: 1500 VAC/minute  
Applicable wire: Conductor size/ AWG#26~#22  
Insulation O.D./ 1.00 to 1.63 mm
- \* Compliant with RoHS2/ REACH
- \* Refer to "General Instruction and Notice when using Terminals and Connectors"
- \* Contact CSG for details

Material:

Housing: PPO/ PBT/ PA66/UL94-V0;Color:Black

Terminal: Bass/ Phosphor/ Tin-plated/ Gold-Plated G/F

- Note: 1. The above figure is the figure viewed from the connector mounting side.  
2. Tolerances are non-cumulative:  $\pm 0.08$  mm for all centers.  
3. The dimensions above should serve as a guideline. Contact CSG for details.

**CSG**

Tel:+86-769-85312070 85375507 E-mail:James@csg-china.com www.csg-china.com www.jst-connector.cn

# A2543 DU Box

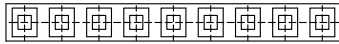
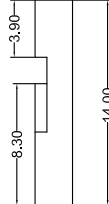
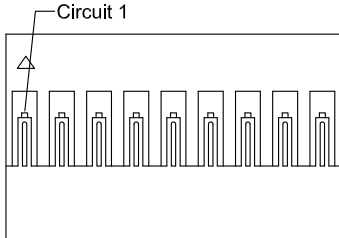
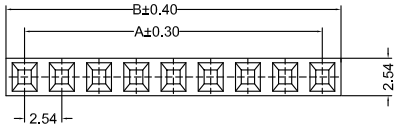

A2543HF 0XX AA XX 0 032

PIN  
005=5PINS

SPECIAL  
AA=NO Special

Material  
PP=PPO  
P6=PA66  
PB=PBT

Code  
032  
Color  
0=Black

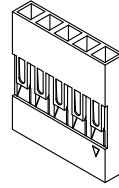

CSG PART NO.	Dimension mm		Q'ty/BAG
	A	B	
A2543HF001AAXX0032	2.54	5.08	1000PCS
A2543HF002AAXX0032	2.54	5.08	1000PCS
A2543HF003AAXX0032	5.08	7.62	1000PCS
A2543HF004AAXX0032	7.62	10.16	1000PCS
A2543HF005AAXX0032	10.16	12.70	1000PCS
A2543HF006AAXX0032	12.70	15.24	1000PCS
A2543HF007AAXX0032	15.24	17.78	1000PCS
A2543HF008AAXX0032	17.78	20.32	1000PCS
A2543HF009AAXX0032	20.32	22.86	1000PCS
A2543HF010AAXX0032	22.86	25.40	1000PCS
A2543HF011AAXX0032	25.40	27.94	1000PCS
A2543HF012AAXX0032	27.94	30.48	1000PCS
A2543HF013AAXX0032	30.48	33.02	1000PCS
A2543HF014AAXX0032	33.02	35.56	1000PCS
A2543HF015AAXX0032	35.56	38.10	1000PCS
A2543HF016AAXX0032	38.10	40.64	1000PCS
A2543HF017AAXX0032	40.64	43.18	1000PCS
A2543HF018AAXX0032	43.18	45.72	1000PCS
A2543HF019AAXX0032	45.72	48.26	1000PCS
A2543HF020AAXX0032	48.26	50.80	1000PCS
A2543HF021AAXX0032	50.80	53.24	1000PCS
A2543HF022AAXX0032	53.24	55.88	1000PCS
A2543HF023AAXX0032	55.88	58.42	1000PCS
A2543HF024AAXX0032	58.42	60.96	1000PCS
A2543HF025AAXX0032	60.96	63.50	1000PCS
A2543HF026AAXX0032	63.50	66.04	1000PCS
A2543HF027AAXX0032	66.04	68.58	1000PCS
A2543HF028AAXX0032	68.58	71.12	1000PCS
A2543HF029AAXX0032	71.12	73.66	1000PCS
A2543HF030AAXX0032	73.66	76.20	1000PCS

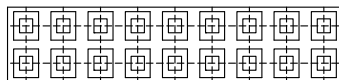
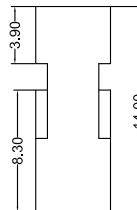
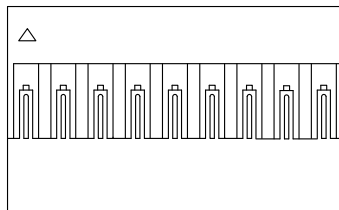
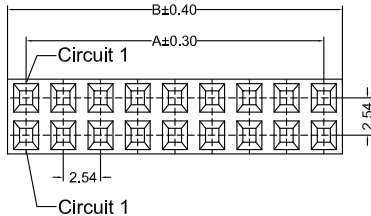

A2543HF 2XX AA XX 0 032

PIN  
205=2X5PINS

SPECIAL  
AA=NO Special

Material  
PP=PPO  
P6=PA66  
PB=PBT

Code  
032  
Color  
0=Black

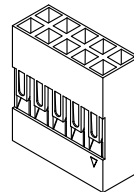

CSG PART NO.	Dimension mm		Q'ty/BAG
	A	B	
A2543HF202AAXX0032	2.54	5.08	1000PCS
A2543HF203AAXX0032	5.08	7.62	1000PCS
A2543HF204AAXX0032	7.62	10.16	1000PCS
A2543HF205AAXX0032	10.16	12.70	1000PCS
A2543HF206AAXX0032	12.70	15.24	1000PCS
A2543HF207AAXX0032	15.24	17.78	1000PCS
A2543HF208AAXX0032	17.78	20.32	1000PCS
A2543HF209AAXX0032	20.32	22.86	1000PCS
A2543HF210AAXX0032	22.86	25.40	1000PCS
A2543HF211AAXX0032	25.40	27.94	1000PCS
A2543HF212AAXX0032	27.94	30.48	1000PCS
A2543HF213AAXX0032	30.48	33.02	1000PCS
A2543HF214AAXX0032	33.02	35.56	1000PCS
A2543HF215AAXX0032	35.56	38.10	1000PCS
A2543HF216AAXX0032	38.10	40.64	1000PCS
A2543HF217AAXX0032	40.64	43.18	1000PCS
A2543HF218AAXX0032	43.18	45.72	1000PCS
A2543HF219AAXX0032	45.72	48.26	1000PCS
A2543HF220AAXX0032	48.26	50.80	1000PCS
A2543HF221AAXX0032	50.80	53.24	1000PCS
A2543HF222AAXX0032	53.24	55.88	1000PCS
A2543HF223AAXX0032	55.88	58.42	1000PCS
A2543HF224AAXX0032	58.42	60.96	1000PCS
A2543HF225AAXX0032	60.96	63.50	1000PCS
A2543HF226AAXX0032	63.50	66.04	1000PCS
A2543HF227AAXX0032	66.04	68.58	1000PCS
A2543HF228AAXX0032	68.58	71.12	1000PCS
A2543HF229AAXX0032	71.12	73.66	1000PCS
A2543HF230AAXX0032	73.66	76.20	1000PCS



# A2543 DU Box

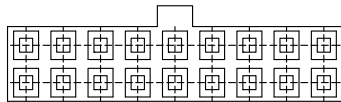
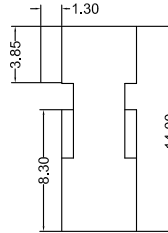
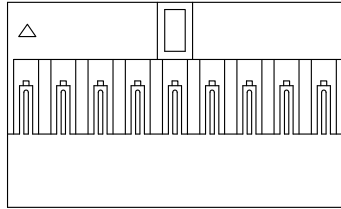
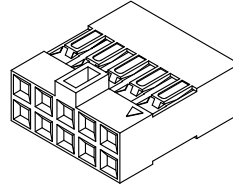
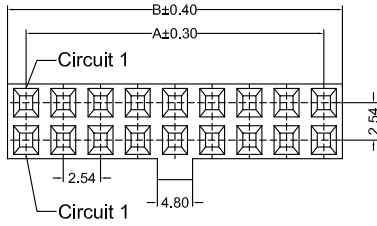

A2543HF 2XX DT XX 0 032

PIN  
205=2X5PINS

SPECIAL  
DT=Low boss

Material  
PP=PPO  
P6=PA66  
PB=PBT

Code  
032  
Color  
0=Black

CSG PART NO.	Dimension mm		Q'ty/BAG
	A	B	
A2543HF202DTXX0032	2.54	5.08	1000PCS
A2543HF203DTXX0032	5.08	7.62	1000PCS
A2543HF204DTXX0032	7.62	10.16	1000PCS
A2543HF205DTXX0032	10.16	12.70	1000PCS
A2543HF206DTXX0032	12.70	15.24	1000PCS
A2543HF207DTXX0032	15.24	17.78	1000PCS
A2543HF208DTXX0032	17.78	20.32	1000PCS
A2543HF209DTXX0032	20.32	22.86	1000PCS
A2543HF210DTXX0032	22.86	25.40	1000PCS
A2543HF211DTXX0032	25.40	27.94	1000PCS
A2543HF212DTXX0032	27.94	30.48	1000PCS
A2543HF213DTXX0032	30.48	33.02	1000PCS
A2543HF214DTXX0032	33.02	35.56	1000PCS
A2543HF215DTXX0032	35.56	38.10	1000PCS
A2543HF216DTXX0032	38.10	40.64	1000PCS
A2543HF217DTXX0032	40.64	43.18	1000PCS
A2543HF218DTXX0032	43.18	45.72	1000PCS
A2543HF219DTXX0032	45.72	48.26	1000PCS
A2543HF220DTXX0032	48.26	50.80	1000PCS
A2543HF221DTXX0032	50.80	53.24	1000PCS
A2543HF222DTXX0032	53.24	55.88	1000PCS
A2543HF223DTXX0032	55.88	58.42	1000PCS
A2543HF224DTXX0032	58.42	60.96	1000PCS
A2543HF225DTXX0032	60.96	63.50	1000PCS
A2543HF226DTXX0032	63.50	66.04	1000PCS
A2543HF227DTXX0032	66.04	68.58	1000PCS
A2543HF228DTXX0032	68.58	71.12	1000PCS
A2543HF229DTXX0032	71.12	73.66	1000PCS
A2543HF230DTXX0032	73.66	76.20	1000PCS

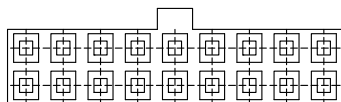
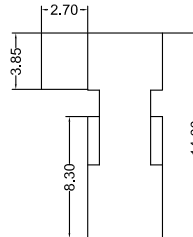
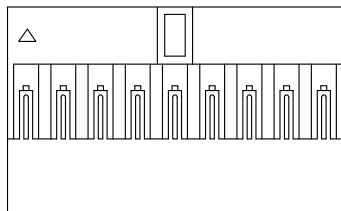
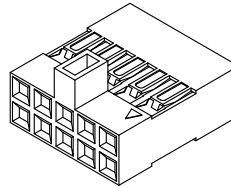
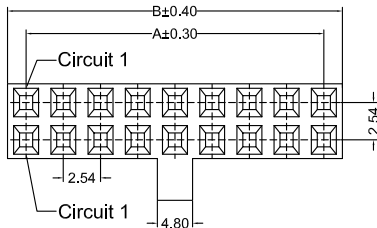

A2543HF 2XX GT XX 0 032

PIN  
205=2X5PINS

SPECIAL  
GT=Low boss

Material  
PP=PPO  
P6=PA66  
PB=PBT

Code  
032  
Color  
0=Black

CSG PART NO.	Dimension mm		Q'ty/BAG
	A	B	
A2543HF202GTXX0032	2.54	5.08	1000PCS
A2543HF203GTXX0032	5.08	7.62	1000PCS
A2543HF204GTXX0032	7.62	10.16	1000PCS
A2543HF205GTXX0032	10.16	12.70	1000PCS
A2543HF206GTXX0032	12.70	15.24	1000PCS
A2543HF207GTXX0032	15.24	17.78	1000PCS
A2543HF208GTXX0032	17.78	20.32	1000PCS
A2543HF209GTXX0032	20.32	22.86	1000PCS
A2543HF210GTXX0032	22.86	25.40	1000PCS
A2543HF211GTXX0032	25.40	27.94	1000PCS
A2543HF212GTXX0032	27.94	30.48	1000PCS
A2543HF213GTXX0032	30.48	33.02	1000PCS
A2543HF214GTXX0032	33.02	35.56	1000PCS
A2543HF215GTXX0032	35.56	38.10	1000PCS
A2543HF216GTXX0032	38.10	40.64	1000PCS
A2543HF217GTXX0032	40.64	43.18	1000PCS
A2543HF218GTXX0032	43.18	45.72	1000PCS
A2543HF219GTXX0032	45.72	48.26	1000PCS
A2543HF220GTXX0032	48.26	50.80	1000PCS
A2543HF221GTXX0032	50.80	53.24	1000PCS
A2543HF222GTXX0032	53.24	55.88	1000PCS
A2543HF223GTXX0032	55.88	58.42	1000PCS
A2543HF224GTXX0032	58.42	60.96	1000PCS
A2543HF225GTXX0032	60.96	63.50	1000PCS
A2543HF226GTXX0032	63.50	66.04	1000PCS
A2543HF227GTXX0032	66.04	68.58	1000PCS
A2543HF228GTXX0032	68.58	71.12	1000PCS
A2543HF229GTXX0032	71.12	73.66	1000PCS
A2543HF230GTXX0032	73.66	76.20	1000PCS



# A2543 DU Box

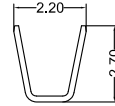
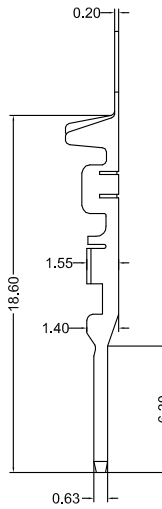
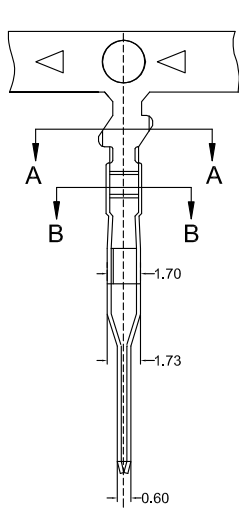

SECTION A-A



SECTION B-B

A2543 F 0 B XX 032

Type  
F=Male Terminal

SPECIAL  
O=NO Special

Material  
B=Bass

Finish  
TP=Tin-Plated  
GF=Gold-Plated

Code  
032

CSG PART NO.	Wire Range	Insulation O.D.	Q'ty/Reel
A2543F0BTP032	AWG#22~#26	1.63mm(max)	10000PCS
A2543F0BGF032	AWG#22~#26	1.63mm(max)	10000PCS

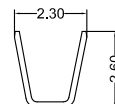
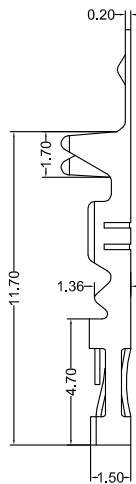
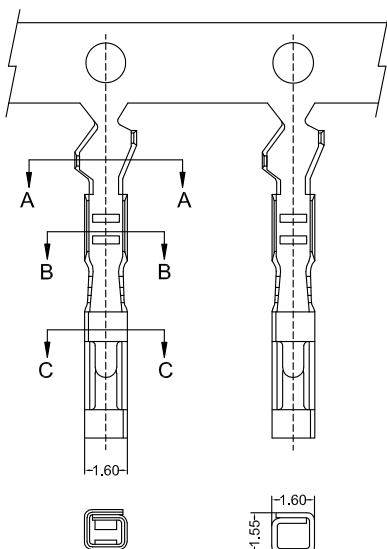

SECTION A-A



SECTION B-B

A2543 M 0 X XX 032

Type  
M=Female Terminal

SPECIAL  
O=NO Special

Material  
A=Phosphor  
B=Bass

Finish  
TP=Tin-Plated  
GF=Gold-Plated G/F

Code  
032

CSG PART NO.	Wire Range	Insulation O.D.	Q'ty/Reel
A2543M0ATP032	AWG#22~#26	1.63mm(max)	10000PCS
A2543M0AGF032	AWG#22~#26	1.63mm(max)	10000PCS
A2543M0BTP032	AWG#22~#26	1.63mm(max)	10000PCS
A2543M0BGF032	AWG#22~#26	1.63mm(max)	10000PCS

**CSG**

Tel:+86-769-85312070 85375507 E-mail:James@csg-china.com www.csg-china.com www.jst-connector.cn