

A2004 PHD CONNECTOR

2.00mm Pitch/Disconnectable Crimp style connectors

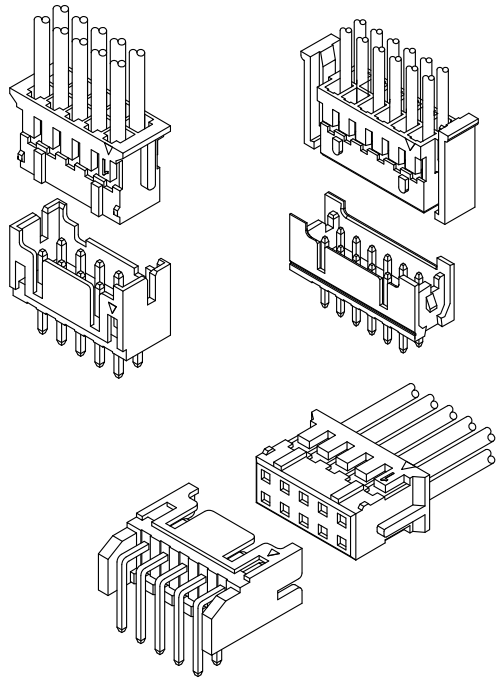

- Secure locking structure
- Low insertion force
- Suction area for picking up
- Improvement of engagement with prying

Specifications:

- Current rating: 3.0 A / AC,DC (AWG #22)
- Voltage rating: 250 V AC/DC
- Temperature range: -25°C ~ +105°C
(including temperature rise in applying electrical current)
- Contact resistance: Initial value/ 10mΩ max
Insulation resistance: 1000 MΩ min
Withstanding voltage: 800 VAC/minute
Applicable wire: Conductor size/ AWG#28~#22
Insulation O.D./ 0.90 to 1.50 mm
- * Compliant with RoHS2/ REACH
- * Refer to "General Instruction and Notice when using Terminals and Connectors"
- * Contact CSG for details

Material:

Housing: PA66/UL94-V0;Color:White
Terminal: Phosphor/ Tin-plated
DIP Wafer Housing: PA9T/ PA66,UL94-V0;
Color:Natural/ Gray
DIP Wafer Pin: Bass/ Tin-plated
SMT Wafer Housing: PA9T,UL94-V0;Color:Natural
SMT Wafer Pin: Bass/ Tin-plated

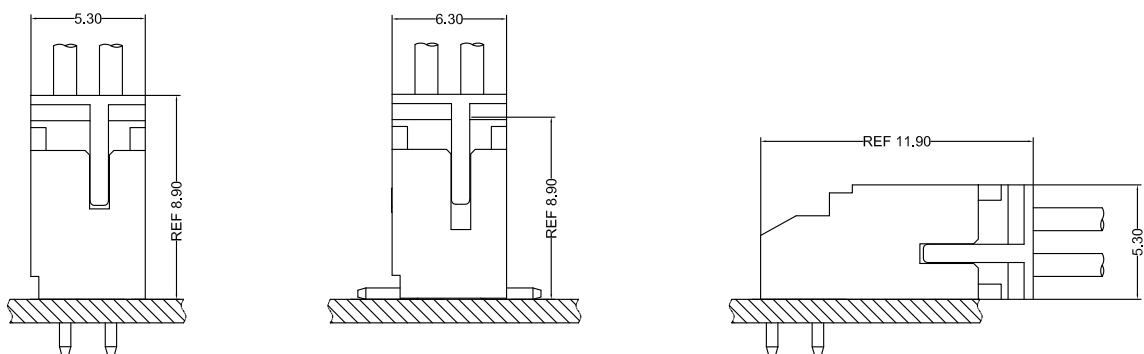

- Note: 1. The above figure is the figure viewed from the connector mounting side.
2. Tolerances are non-cumulative: ±0.08 mm for all centers.
3. The dimensions above should serve as a guideline. Contact CSG for details.

CSG

Tel:+86-769-85312070 85375507 E-mail:James@csg-china.com www.csg-china.com www.jst-connector.cn

A2004 PHD

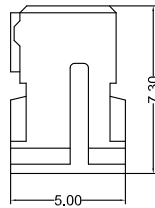
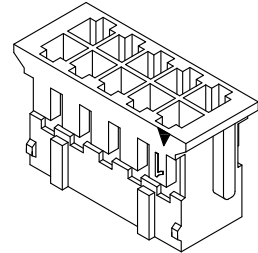
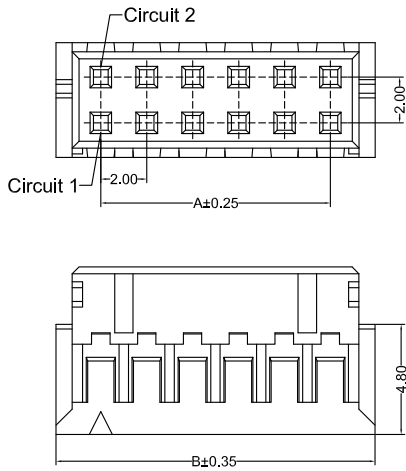

A2004HF 2XX AA P6 9 005
 PIN
 205=2X5PINS
 SPECIAL
 AA=NO Special
 Material
 P6=PA66 94V-0

Code
 005
 Color
 9=White

CSG PART NO.	Dimension mm		Q'ty/BAG
	A	B	
A2004HF203AAP69005	4.00	8.00	1000PCS
A2004HF204AAP69005	6.00	10.00	1000PCS
A2004HF205AAP69005	8.00	12.00	1000PCS
A2004HF206AAP69005	10.00	14.00	1000PCS
A2004HF207AAP69005	12.00	16.00	1000PCS
A2004HF208AAP69005	14.00	18.00	1000PCS
A2004HF209AAP69005	16.00	20.00	1000PCS
A2004HF210AAP69005	18.00	22.00	1000PCS
A2004HF211AAP69005	20.00	24.00	1000PCS
A2004HF212AAP69005	22.00	26.00	1000PCS
A2004HF213AAP69005	24.00	28.00	1000PCS
A2004HF214AAP69005	26.00	30.00	1000PCS
A2004HF215AAP69005	28.00	32.00	1000PCS
A2004HF216AAP69005	30.00	34.00	1000PCS
A2004HF217AAP69005	32.00	36.00	1000PCS
A2004HF218AAP69005	34.00	38.00	1000PCS
A2004HF219AAP69005	36.00	40.00	1000PCS
A2004HF220AAP69005	38.00	42.00	1000PCS
A2004HF221AAP69005	40.00	44.00	1000PCS
A2004HF222AAP69005	42.00	46.00	1000PCS

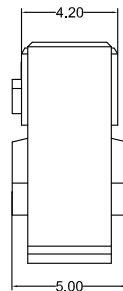
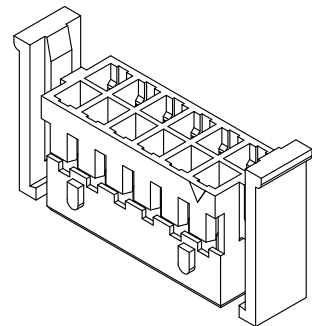
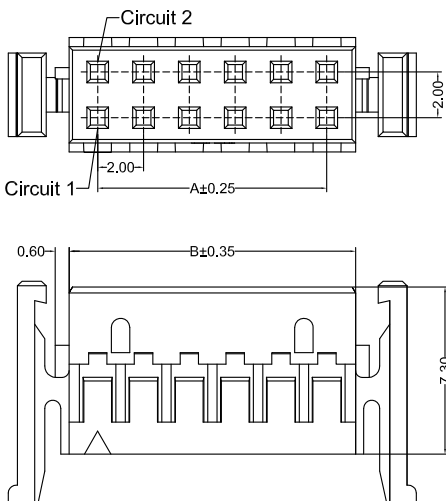

A2004HF 2XX AK P6 9 123
 PIN
 205=2X5PINS
 SPECIAL
 AK=BUCKLE
 Material
 P6=PA66 94V-0

Code
 123
 Color
 9=White

CSG PART NO.	Dimension mm		Q'ty/BAG
	A	B	
A2004HF203AKP69123	4.00	6.50	1000PCS
A2004HF204AKP69123	6.00	8.50	1000PCS
A2004HF205AKP69123	8.00	10.50	1000PCS
A2004HF206AKP69123	10.00	12.50	1000PCS
A2004HF207AKP69123	12.00	14.50	1000PCS
A2004HF208AKP69123	14.00	16.50	1000PCS
A2004HF209AKP69123	16.00	18.50	1000PCS
A2004HF210AKP69123	18.00	20.50	1000PCS
A2004HF211AKP69123	20.00	22.50	1000PCS
A2004HF212AKP69123	22.00	24.50	1000PCS
A2004HF213AKP69123	24.00	26.50	1000PCS
A2004HF214AKP69123	26.00	28.50	1000PCS
A2004HF215AKP69123	28.00	30.50	1000PCS
A2004HF216AKP69123	30.00	32.50	1000PCS
A2004HF217AKP69123	32.00	34.50	1000PCS
A2004HF218AKP69123	34.00	36.50	1000PCS
A2004HF219AKP69123	36.00	38.50	1000PCS
A2004HF220AKP69123	38.00	40.50	1000PCS



A2004 PHD

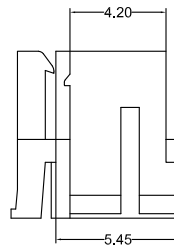
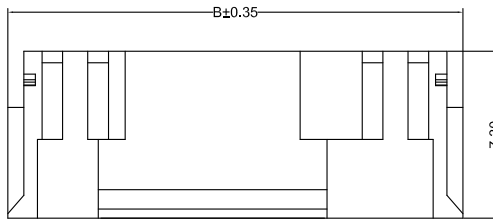
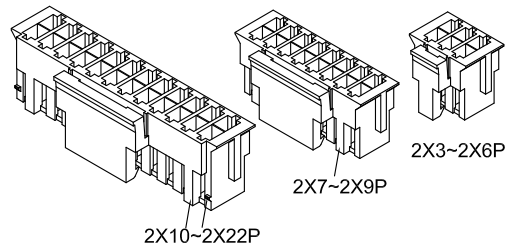
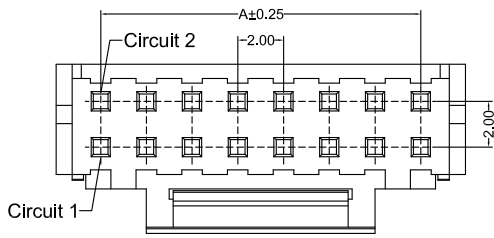

A2004HF 2XX AK P6 9 001
 PIN
 205=2X5PINS
 SPECIAL
 AK=BUCKLE
 Material
 P6=PA66 94V-0
 Code
 001
 Color
 9=White

CSG PART NO.	Dimension mm		Q'ty/BAG
	A	B	
A2004HF203AKP69001	4.00	6.50	1000PCS
A2004HF204AKP69001	6.00	8.50	1000PCS
A2004HF205AKP69001	8.00	10.50	1000PCS
A2004HF206AKP69001	10.00	12.50	1000PCS
A2004HF207AKP69001	12.00	14.50	1000PCS
A2004HF208AKP69001	14.00	16.50	1000PCS
A2004HF209AKP69001	16.00	18.50	1000PCS
A2004HF210AKP69001	18.00	20.50	1000PCS
A2004HF211AKP69001	20.00	22.50	1000PCS
A2004HF212AKP69001	22.00	24.50	1000PCS
A2004HF213AKP69001	24.00	26.50	1000PCS
A2004HF214AKP69001	26.00	28.50	1000PCS
A2004HF215AKP69001	28.00	30.50	1000PCS
A2004HF216AKP69001	30.00	32.50	1000PCS
A2004HF217AKP69001	32.00	34.50	1000PCS
A2004HF218AKP69001	34.00	36.50	1000PCS
A2004HF219AKP69001	36.00	38.50	1000PCS
A2004HF220AKP69001	38.00	40.50	1000PCS
A2004HF221AKP69001	40.00	42.50	1000PCS
A2004HF222AKP69001	42.00	44.50	1000PCS

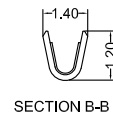
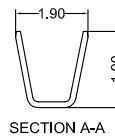
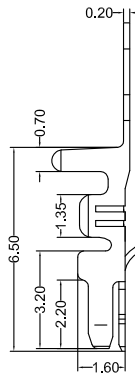
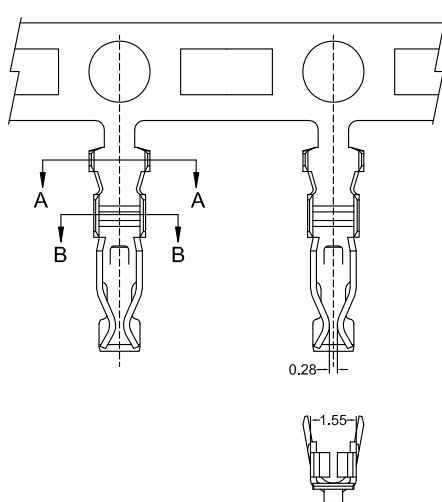

A2004 M O A TP 002
 Type
 M=Female Terminal
 SPECIAL
 O=NO Special
 Material
 A=Phosphor
 Finish
 TP=Tin-Plated
 Code
 002

CSG PART NO.	Wire Range	Insulation O.D.	Q'ty/Reel
A2004M0ATP002	AWG#22-#28	1.50mm(max)	12000PCS



A2004 PHD

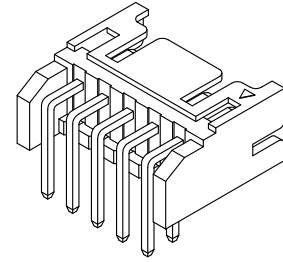
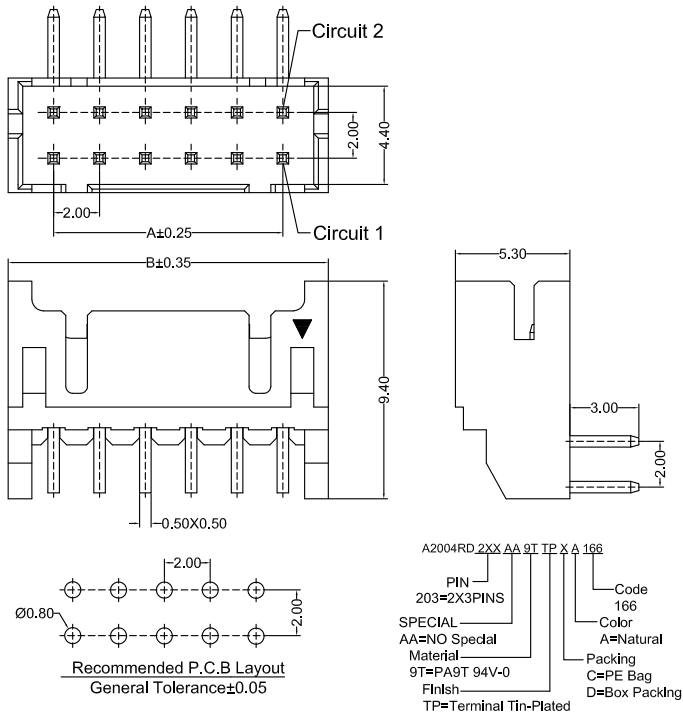

CSG PART NO.	Dimension mm		Q'ty
	A	B	
A2004RD203AA9TTPXA166	4.00	8.00	1000PCS
A2004RD204AA9TTPXA166	6.00	10.00	1000PCS
A2004RD205AA9TTPXA166	8.00	12.00	1000PCS
A2004RD206AA9TTPXA166	10.00	14.00	1000PCS
A2004RD207AA9TTPXA166	12.00	16.00	1000PCS
A2004RD208AA9TTPXA166	14.00	18.00	1000PCS
A2004RD209AA9TTPXA166	16.00	20.00	1000PCS
A2004RD210AA9TTPXA166	18.00	22.00	1000PCS
A2004RD211AA9TTPXA166	20.00	24.00	1000PCS
A2004RD212AA9TTPXA166	22.00	26.00	1000PCS
A2004RD213AA9TTPXA166	24.00	28.00	1000PCS
A2004RD214AA9TTPXA166	26.00	30.00	1000PCS
A2004RD215AA9TTPXA166	28.00	32.00	1000PCS
A2004RD216AA9TTPXA166	30.00	34.00	1000PCS
A2004RD217AA9TTPXA166	32.00	36.00	1000PCS
A2004RD218AA9TTPXA166	34.00	38.00	1000PCS
A2004RD219AA9TTPXA166	36.00	40.00	1000PCS
A2004RD220AA9TTPXA166	38.00	42.00	1000PCS
A2004RD221AA9TTPXA166	40.00	44.00	1000PCS
A2004RD222AA9TTPXA166	42.00	46.00	1000PCS

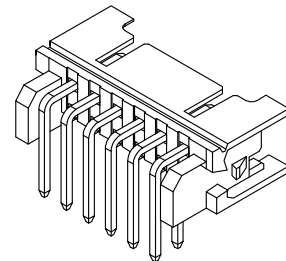
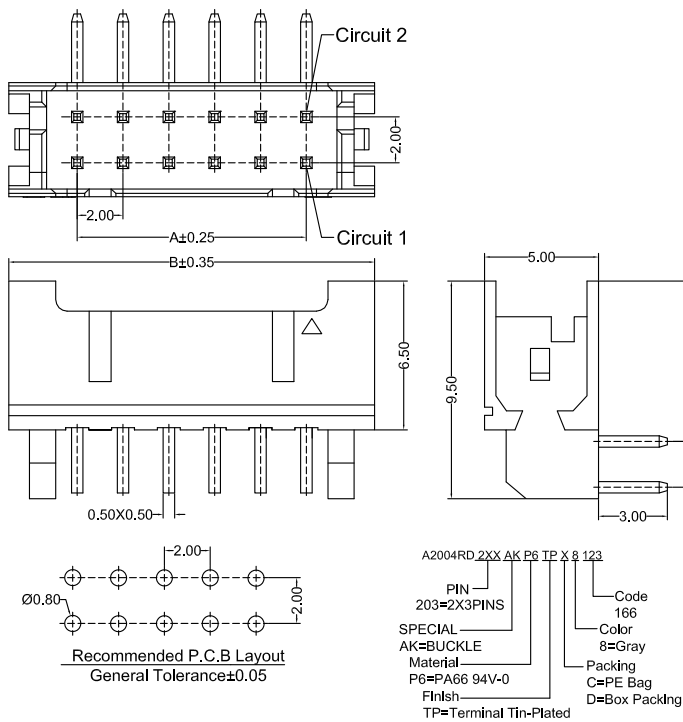

CSG PART NO.	Dimension mm		Q'ty
	A	B	
A2004RD203AKP6TPX8123	4.00	10.00	1000PCS
A2004RD204AKP6TPX8123	6.00	12.00	1000PCS
A2004RD205AKP6TPX8123	8.00	14.00	1000PCS
A2004RD206AKP6TPX8123	10.00	16.00	1000PCS
A2004RD207AKP6TPX8123	12.00	18.00	1000PCS
A2004RD208AKP6TPX8123	14.00	20.00	1000PCS
A2004RD209AKP6TPX8123	16.00	22.00	1000PCS
A2004RD210AKP6TPX8123	18.00	24.00	1000PCS
A2004RD211AKP6TPX8123	20.00	26.00	1000PCS
A2004RD212AKP6TPX8123	22.00	28.00	1000PCS
A2004RD213AKP6TPX8123	24.00	30.00	1000PCS
A2004RD214AKP6TPX8123	26.00	32.00	1000PCS
A2004RD215AKP6TPX8123	28.00	34.00	1000PCS
A2004RD216AKP6TPX8123	30.00	36.00	1000PCS
A2004RD217AKP6TPX8123	32.00	38.00	1000PCS
A2004RD218AKP6TPX8123	34.00	40.00	1000PCS
A2004RD219AKP6TPX8123	36.00	42.00	1000PCS
A2004RD220AKP6TPX8123	38.00	44.00	1000PCS



A2004 PHD

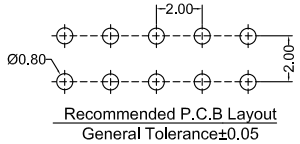
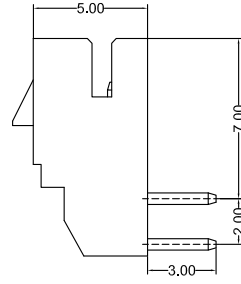
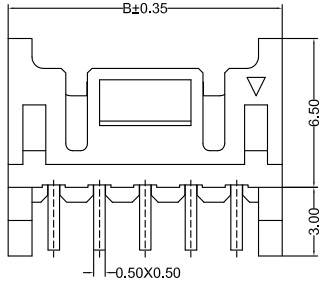
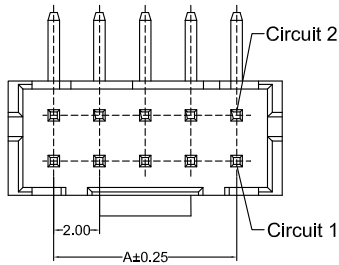

A2004RD 2XX AK 9T TP X A 166
 PIN
 203=2X3PINS
 SPECIAL
 AK=BUCKLE
 Material
 9T=PA9T 94V-0
 Finish
 TP=Terminal Tin-Plated
 Code
 166
 Color
 A=Natural
 Packing
 C=PE Bag
 D=Box Packing

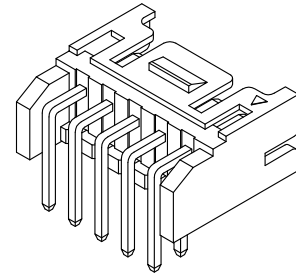

CSG PART NO.	Dimension mm		Q'ty
	A	B	
A2004RD203AK9TTPXA166	4.00	10.00	1000PCS
A2004RD204AK9TTPXA166	6.00	12.00	1000PCS
A2004RD205AK9TTPXA166	8.00	14.00	1000PCS
A2004RD206AK9TTPXA166	10.00	16.00	1000PCS
A2004RD207AK9TTPXA166	12.00	18.00	1000PCS
A2004RD208AK9TTPXA166	14.00	20.00	1000PCS
A2004RD209AK9TTPXA166	16.00	22.00	1000PCS
A2004RD210AK9TTPXA166	18.00	24.00	1000PCS
A2004RD211AK9TTPXA166	20.00	26.00	1000PCS
A2004RD212AK9TTPXA166	22.00	28.00	1000PCS
A2004RD213AK9TTPXA166	24.00	30.00	1000PCS
A2004RD214AK9TTPXA166	26.00	32.00	1000PCS
A2004RD215AK9TTPXA166	28.00	34.00	1000PCS
A2004RD216AK9TTPXA166	30.00	36.00	1000PCS
A2004RD217AK9TTPXA166	32.00	38.00	1000PCS
A2004RD218AK9TTPXA166	34.00	40.00	1000PCS
A2004RD219AK9TTPXA166	36.00	42.00	1000PCS
A2004RD220AK9TTPXA166	38.00	44.00	1000PCS
A2004RD221AK9TTPXA166	40.00	46.00	1000PCS
A2004RD222AK9TTPXA166	42.00	48.00	1000PCS

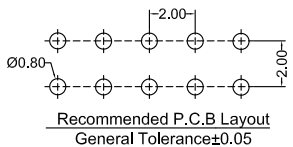
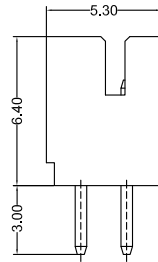
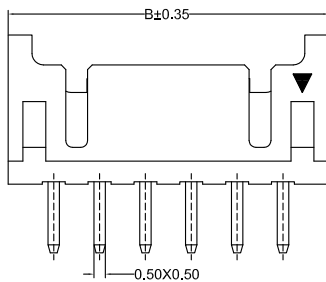
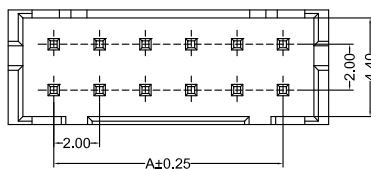

A2004VD 2XX AA 9T TP X A 166
 PIN
 203=2X3PINS
 SPECIAL
 AA=NO Special
 Material
 9T=PA9T 94V-0
 Finish
 TP=Terminal Tin-Plated
 Code
 166
 Color
 A=Natural
 Packing
 C=PE Bag
 D=Box Packing

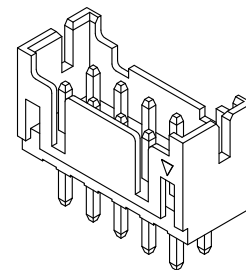

CSG PART NO.	Dimension mm		Q'ty
	A	B	
A2004VD203AA9TTPXA166	4.00	8.00	1000PCS
A2004VD204AA9TTPXA166	6.00	10.00	1000PCS
A2004VD205AA9TTPXA166	8.00	12.00	1000PCS
A2004VD206AA9TTPXA166	10.00	14.00	1000PCS
A2004VD207AA9TTPXA166	12.00	16.00	1000PCS
A2004VD208AA9TTPXA166	14.00	18.00	1000PCS
A2004VD209AA9TTPXA166	16.00	20.00	1000PCS
A2004VD210AA9TTPXA166	18.00	22.00	1000PCS
A2004VD211AA9TTPXA166	20.00	24.00	1000PCS
A2004VD212AA9TTPXA166	22.00	26.00	1000PCS
A2004VD213AA9TTPXA166	24.00	28.00	1000PCS
A2004VD214AA9TTPXA166	26.00	30.00	1000PCS
A2004VD215AA9TTPXA166	28.00	32.00	1000PCS
A2004VD216AA9TTPXA166	30.00	34.00	1000PCS
A2004VD217AA9TTPXA166	32.00	36.00	1000PCS
A2004VD218AA9TTPXA166	34.00	38.00	1000PCS
A2004VD219AA9TTPXA166	36.00	40.00	1000PCS
A2004VD220AA9TTPXA166	38.00	42.00	1000PCS
A2004VD221AA9TTPXA166	40.00	44.00	1000PCS
A2004VD222AA9TTPXA166	42.00	46.00	1000PCS



A2004 PHD

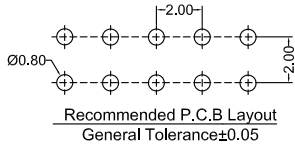
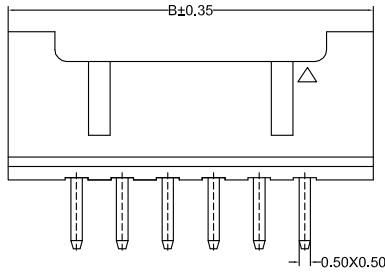
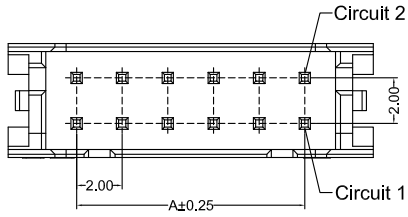

A2004VD 2XX AK P6 TP X & 123

PIN
203=2X3PINS

SPECIAL
AK=BUCKLE

Material
P6=PA66 94V-0

Finish
TP=Terminal Tin-Plated

Code
166

Color
8=Gray

Packing
C=PE Bag
D=Box Packing

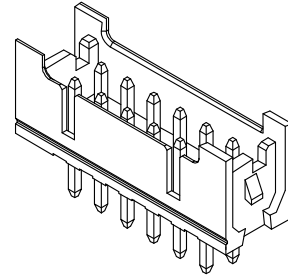

CSG PART NO.	Dimension mm		Q'ty
	A	B	
A2004VD203AKP6TPX8123	4.00	10.00	1000PCS
A2004VD204AKP6TPX8123	6.00	12.00	1000PCS
A2004VD205AKP6TPX8123	8.00	14.00	1000PCS
A2004VD206AKP6TPX8123	10.00	16.00	1000PCS
A2004VD207AKP6TPX8123	12.00	18.00	1000PCS
A2004VD208AKP6TPX8123	14.00	20.00	1000PCS
A2004VD209AKP6TPX8123	16.00	22.00	1000PCS
A2004VD210AKP6TPX8123	18.00	24.00	1000PCS
A2004VD211AKP6TPX8123	20.00	26.00	1000PCS
A2004VD212AKP6TPX8123	22.00	28.00	1000PCS
A2004VD213AKP6TPX8123	24.00	30.00	1000PCS
A2004VD214AKP6TPX8123	26.00	32.00	1000PCS
A2004VD215AKP6TPX8123	28.00	34.00	1000PCS
A2004VD216AKP6TPX8123	30.00	36.00	1000PCS
A2004VD217AKP6TPX8123	32.00	38.00	1000PCS
A2004VD218AKP6TPX8123	34.00	40.00	1000PCS
A2004VD219AKP6TPX8123	36.00	42.00	1000PCS
A2004VD220AKP6TPX8123	38.00	44.00	1000PCS

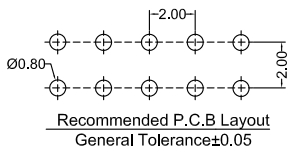
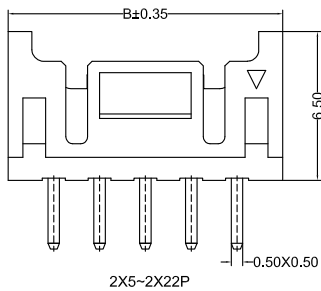
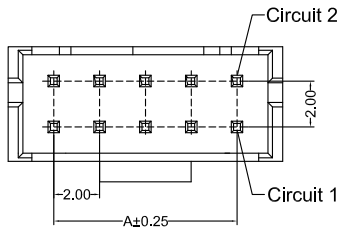

A2004VD 2XX AK 9T TP X A 166

PIN
203=2X3PINS

SPECIAL
AK=BUCKLE

Material
9T=PA9T 94V-0

Finish
TP=Terminal Tin-Plated

Code
166

Color
A=Natural

Packing
C=PE Bag
D=Box Packing

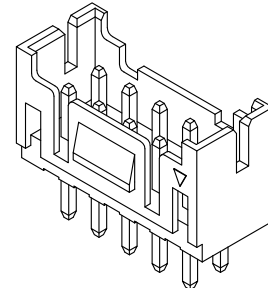

CSG PART NO.	Dimension mm		Q'ty
	A	B	
A2004VD203AK9TTPXA166	4.00	10.00	1000PCS
A2004VD204AK9TTPXA166	6.00	12.00	1000PCS
A2004VD205AK9TTPXA166	8.00	14.00	1000PCS
A2004VD206AK9TTPXA166	10.00	16.00	1000PCS
A2004VD207AK9TTPXA166	12.00	18.00	1000PCS
A2004VD208AK9TTPXA166	14.00	20.00	1000PCS
A2004VD209AK9TTPXA166	16.00	22.00	1000PCS
A2004VD210AK9TTPXA166	18.00	24.00	1000PCS
A2004VD211AK9TTPXA166	20.00	26.00	1000PCS
A2004VD212AK9TTPXA166	22.00	28.00	1000PCS
A2004VD213AK9TTPXA166	24.00	30.00	1000PCS
A2004VD214AK9TTPXA166	26.00	32.00	1000PCS
A2004VD215AK9TTPXA166	28.00	34.00	1000PCS
A2004VD216AK9TTPXA166	30.00	36.00	1000PCS
A2004VD217AK9TTPXA166	32.00	38.00	1000PCS
A2004VD218AK9TTPXA166	34.00	40.00	1000PCS
A2004VD219AK9TTPXA166	36.00	42.00	1000PCS
A2004VD220AK9TTPXA166	38.00	44.00	1000PCS
A2004VD221AK9TTPXA166	40.00	46.00	1000PCS
A2004VD222AK9TTPXA166	42.00	48.00	1000PCS



A2004 PHD

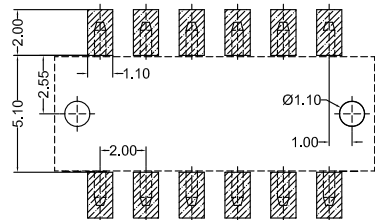
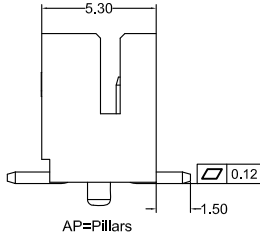
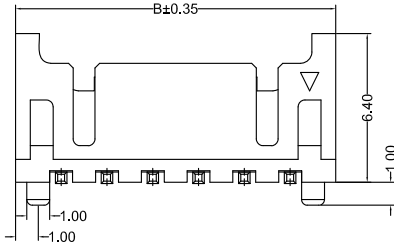
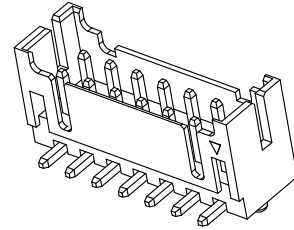
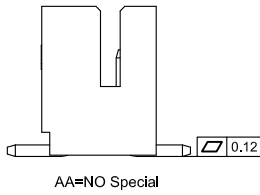
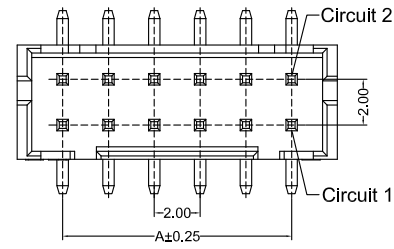

Recommended P.C.B Layout
General Tolerance±0.05

A2004VS.2XX AX 9T TP B A 166

PIN
203=2X3PINS

SPECIAL
AA=NO Special
AP=Pillars

Material
9T=PA9T 94V-0
Finish
TP=Terminal Tin-Plated

Code
166
Color
A=Natural
Packing
B=Tape & Reel

CSG PART NO.	Dimension mm		Q'ty/Reel
	A	B	
A2004VS203AX9TTPBA166	4.00	8.00	500PCS
A2004VS204AX9TTPBA166	6.00	10.00	500PCS
A2004VS205AX9TTPBA166	8.00	12.00	500PCS
A2004VS206AX9TTPBA166	10.00	14.00	500PCS
A2004VS207AX9TTPBA166	12.00	16.00	500PCS
A2004VS208AX9TTPBA166	14.00	18.00	500PCS
A2004VS209AX9TTPBA166	16.00	20.00	500PCS
A2004VS210AX9TTPBA166	18.00	22.00	500PCS
A2004VS211AX9TTPBA166	20.00	24.00	500PCS
A2004VS212AX9TTPBA166	22.00	26.00	500PCS
A2004VS213AX9TTPBA166	24.00	28.00	500PCS
A2004VS214AX9TTPBA166	26.00	30.00	500PCS
A2004VS215AX9TTPBA166	28.00	32.00	500PCS
A2004VS216AX9TTPBA166	30.00	34.00	500PCS
A2004VS217AX9TTPBA166	32.00	36.00	500PCS
A2004VS218AX9TTPBA166	34.00	38.00	500PCS
A2004VS219AX9TTPBA166	36.00	40.00	500PCS
A2004VS220AX9TTPBA166	38.00	42.00	500PCS
A2004RS221AX9TTPBA166	40.00	44.00	500PCS
A2004VS222AX9TTPBA166	42.00	46.00	500PCS