

A2023 PHB CONNECTOR

2.00mm Pitch/Disconnectable Crimp style connectors

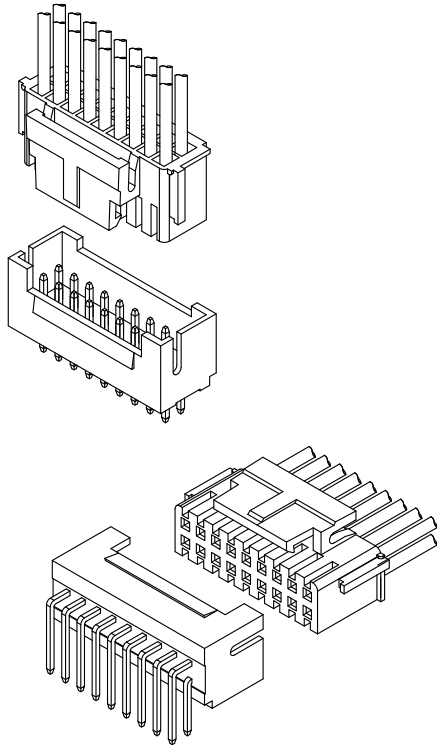

CSG E529482

Specifications:

- Current rating: 3 A AC,DC (AWG #22)
 - Voltage rating: 250 V AC/DC
 - Temperature range: -25°C ~ +105°C
(including temperature rise in applying electrical current)
 - Contact resistance: Initial value/ 10m Ω max
After environmental testing/ 20m Ω max
 - Insulation resistance: 1000 M Ω min
 - Withstanding voltage: 800 VAC/minute
 - Applicable wire: Conductor size/ AWG#28~#22
Insulation O.D./ 0.76 to 1.50 mm
- * Compliant with RoHS2/ REACH
* Refer to "General Instruction and Notice when using Terminals and Connectors"
* Contact CSG for details

Material:

Housing: PA66/UL94-V0;Color:White
Terminal: Phosphor/ Tin-plated
DIP Wafer Housing: PA46,UL94-V0;Color:Natural
DIP Pin: Brass/ Tin-plated
SMT Wafer Housing: LCP,UL94-V0;Color:Natural
SMT Wafer Pin: Bass/ Tin-plated
SMT Wafer Fixed Foot: Bass/ Tin-plated

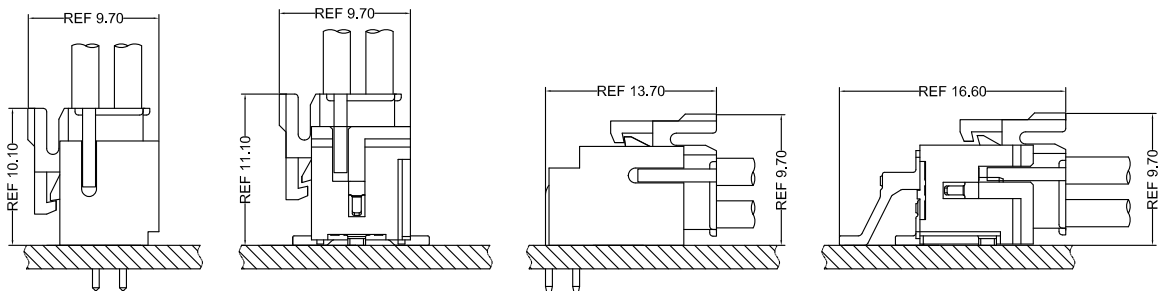

- Note: 1. The above figure is the figure viewed from the connector mounting side.
2. Tolerances are non-cumulative: ± 0.08 mm for all centers.
3. The dimensions above should serve as a guideline. Contact CSG for details.

CSG

Tel: +86-769-85312070 85375507 E-mail: James@csg-china.com www.csg-china.com www.jst-connector.cn

A2023 PHB

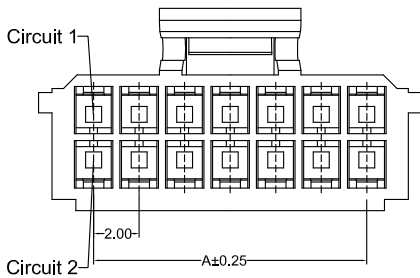
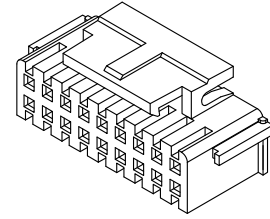
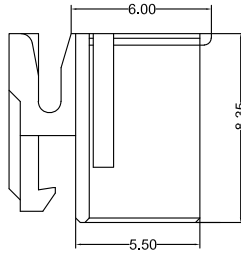
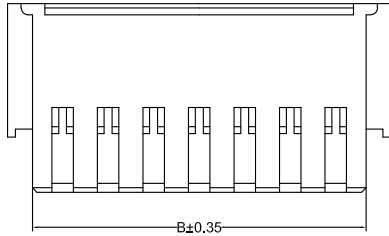

A2023HF 2XX AK P6 9 XXX
 PIN
 205=2X5PINS
 SPECIAL
 AK=BUCKLE
 Material
 P6=PA66 94V-0
 Code
 001
 005
 Color
 9=White

CSG PART NO.	Dimension mm		Q'ty/BAG
	A	B	
A2023HF202AKP69XXX	2.00	4.60	1000PCS
A2023HF203AKP69XXX	4.00	6.60	1000PCS
A2023HF204AKP69XXX	6.00	8.60	1000PCS
A2023HF205AKP69XXX	8.00	10.60	1000PCS
A2023HF206AKP69XXX	10.00	12.60	1000PCS
A2023HF207AKP69XXX	12.00	14.60	1000PCS
A2023HF208AKP69XXX	14.00	16.60	1000PCS
A2023HF209AKP69XXX	16.00	18.60	1000PCS
A2023HF210AKP69XXX	18.00	20.60	1000PCS
A2023HF211AKP69XXX	20.00	22.60	1000PCS
A2023HF212AKP69XXX	22.00	24.60	1000PCS
A2023HF213AKP69XXX	24.00	26.60	1000PCS
A2023HF214AKP69XXX	26.00	28.60	1000PCS
A2023HF215AKP69XXX	28.00	30.60	1000PCS
A2023HF216AKP69XXX	30.00	32.60	1000PCS
A2023HF217AKP69XXX	32.00	34.60	1000PCS
A2023HF218AKP69XXX	34.00	36.60	1000PCS
A2023HF219AKP69XXX	36.00	38.60	1000PCS
A2023HF220AKP69XXX	38.00	40.60	1000PCS

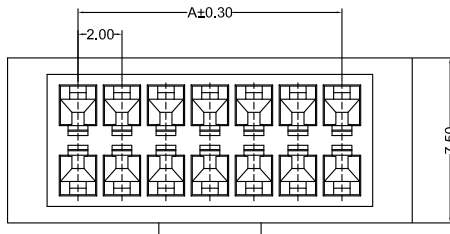

A2023HM 2XX AA P6 9 005
 PIN
 205=2X5PINS
 SPECIAL
 AA=NO Special
 Material
 P6=PA66 94V-0
 Code
 005
 Color
 9=White

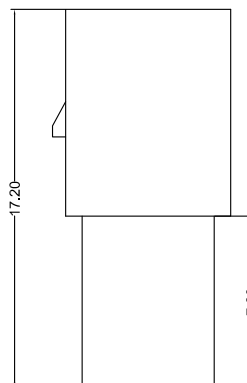
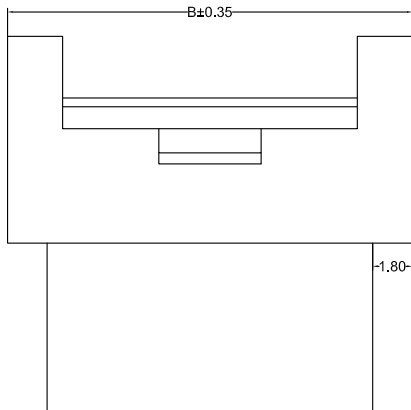
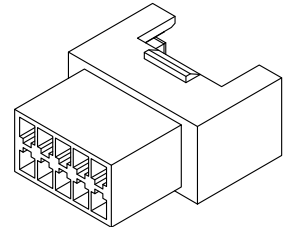

CSG PART NO.	Dimension mm		Q'ty/BAG
	A	B	
A2023HM202AAP69005	2.00	8.40	1000PCS
A2023HM203AAP69005	4.00	10.40	1000PCS
A2023HM204AAP69005	6.00	12.40	1000PCS
A2023HM205AAP69005	8.00	14.40	1000PCS
A2023HM206AAP69005	10.00	16.40	1000PCS
A2023HM207AAP69005	12.00	18.40	1000PCS
A2023HM208AAP69005	14.00	20.40	1000PCS
A2023HM209AAP69005	16.00	22.40	1000PCS
A2023HM210AAP69005	18.00	24.40	1000PCS
A2023HM212AAP69005	20.00	26.40	1000PCS
A2023HM212AAP69005	22.00	28.40	1000PCS
A2023HM213AAP69005	24.00	30.40	1000PCS
A2023HM214AAP69005	26.00	32.40	1000PCS
A2023HM215AAP69005	28.00	34.40	1000PCS
A2023HM218AAP69005	32.00	40.40	1000PCS



A2023 PHB

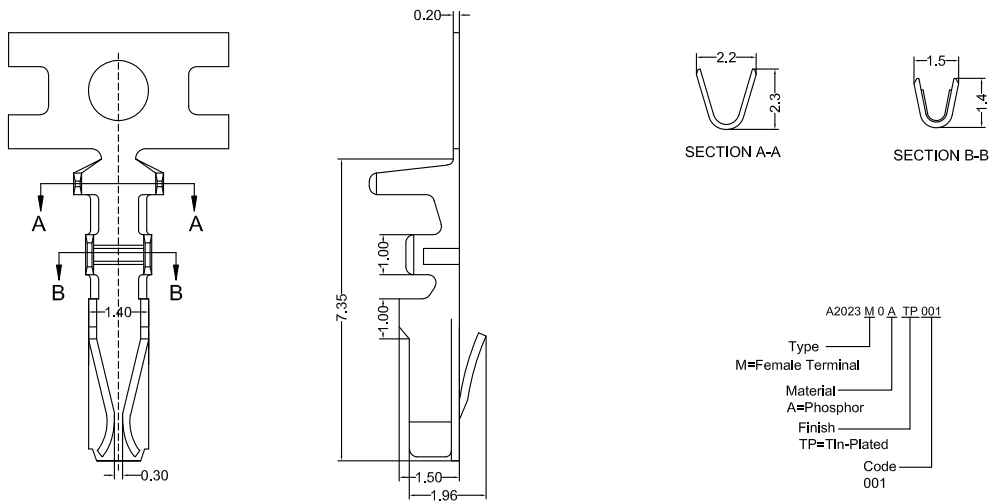
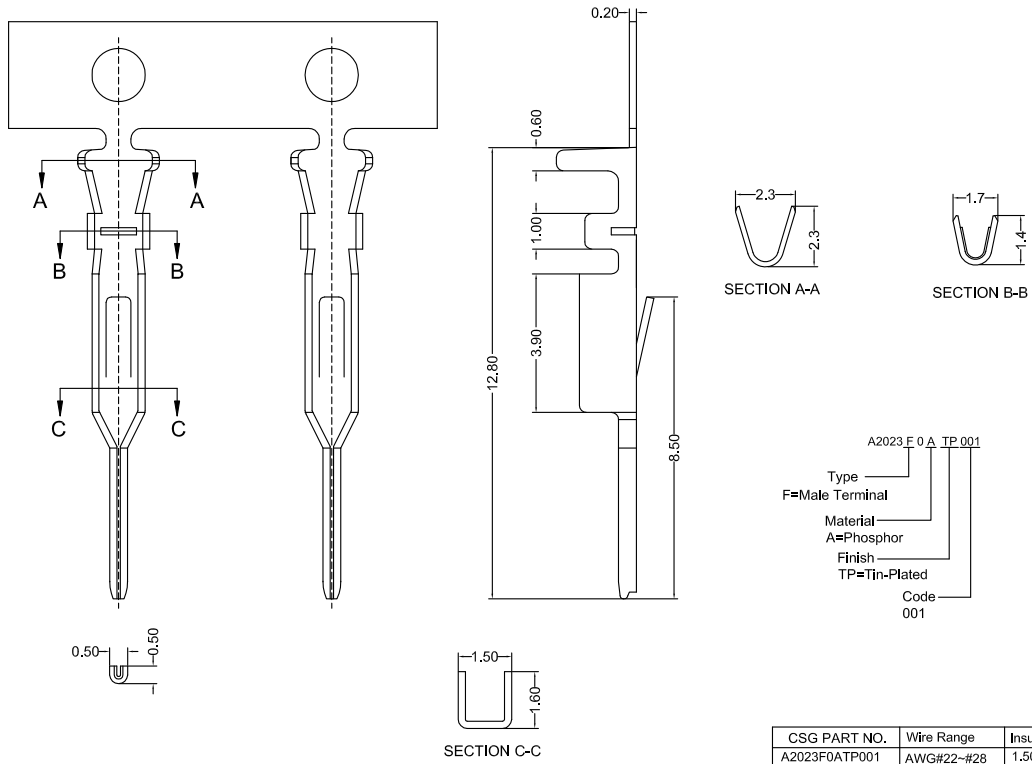

CSG

A2023 PHB

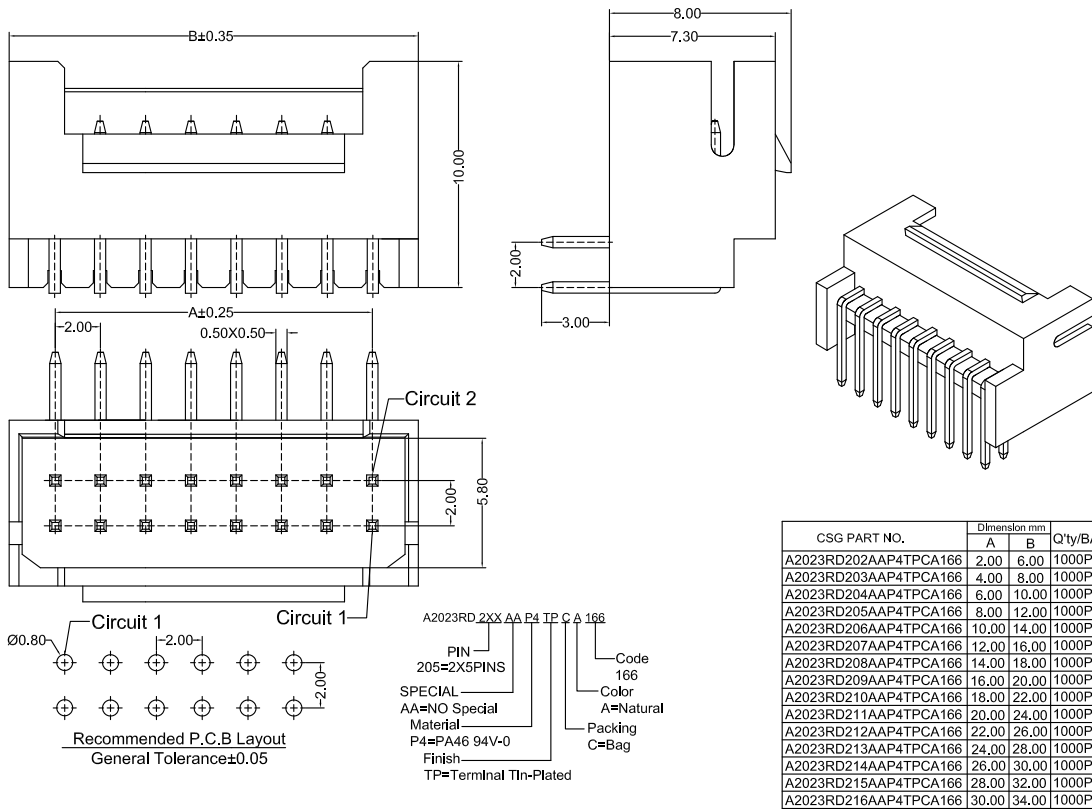

CSG PART NO.	Dimension mm		Q'ty/BAG
	A	B	
A2023RD202AAP4TPCA166	2.00	6.00	1000PCS
A2023RD203AAP4TPCA166	4.00	8.00	1000PCS
A2023RD204AAP4TPCA166	6.00	10.00	1000PCS
A2023RD205AAP4TPCA166	8.00	12.00	1000PCS
A2023RD206AAP4TPCA166	10.00	14.00	1000PCS
A2023RD207AAP4TPCA166	12.00	16.00	1000PCS
A2023RD208AAP4TPCA166	14.00	18.00	1000PCS
A2023RD209AAP4TPCA166	16.00	20.00	1000PCS
A2023RD210AAP4TPCA166	18.00	22.00	1000PCS
A2023RD211AAP4TPCA166	20.00	24.00	1000PCS
A2023RD212AAP4TPCA166	22.00	26.00	1000PCS
A2023RD213AAP4TPCA166	24.00	28.00	1000PCS
A2023RD214AAP4TPCA166	26.00	30.00	1000PCS
A2023RD215AAP4TPCA166	28.00	32.00	1000PCS
A2023RD216AAP4TPCA166	30.00	34.00	1000PCS

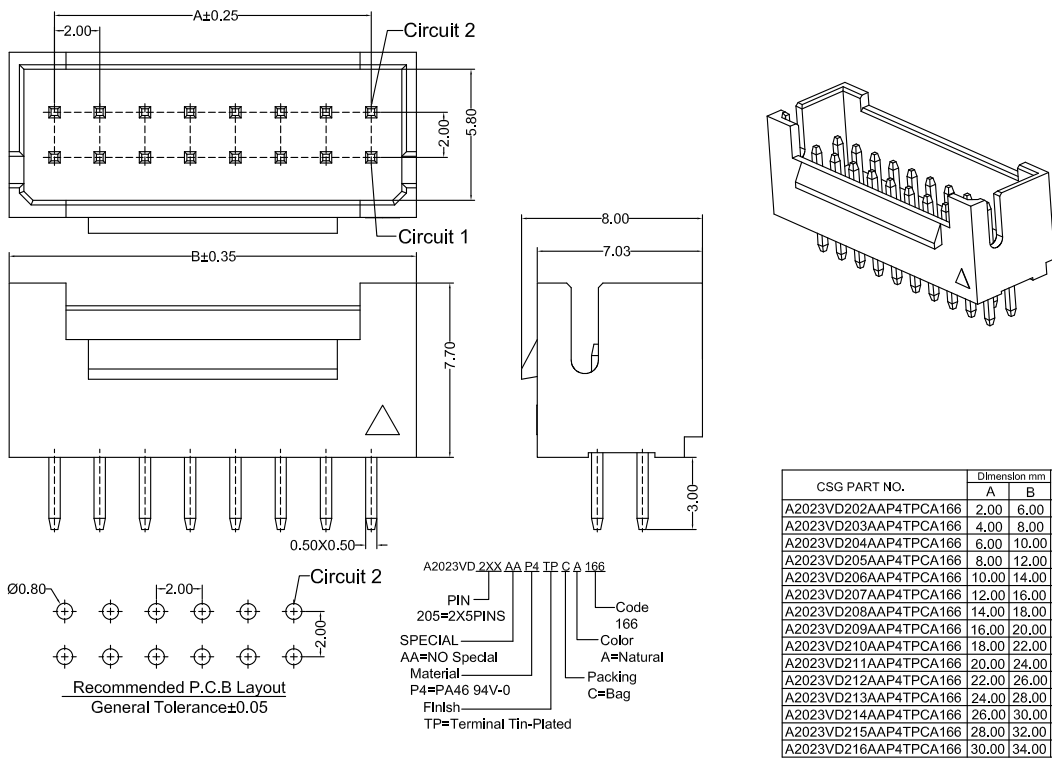

CSG PART NO.	Dimension mm		Q'ty/BAG
	A	B	
A2023VD202AAP4TPCA166	2.00	6.00	1000PCS
A2023VD203AAP4TPCA166	4.00	8.00	1000PCS
A2023VD204AAP4TPCA166	6.00	10.00	1000PCS
A2023VD205AAP4TPCA166	8.00	12.00	1000PCS
A2023VD206AAP4TPCA166	10.00	14.00	1000PCS
A2023VD207AAP4TPCA166	12.00	16.00	1000PCS
A2023VD208AAP4TPCA166	14.00	18.00	1000PCS
A2023VD209AAP4TPCA166	16.00	20.00	1000PCS
A2023VD210AAP4TPCA166	18.00	22.00	1000PCS
A2023VD211AAP4TPCA166	20.00	24.00	1000PCS
A2023VD212AAP4TPCA166	22.00	26.00	1000PCS
A2023VD213AAP4TPCA166	24.00	28.00	1000PCS
A2023VD214AAP4TPCA166	26.00	30.00	1000PCS
A2023VD215AAP4TPCA166	28.00	32.00	1000PCS
A2023VD216AAP4TPCA166	30.00	34.00	1000PCS



A2023 PHB

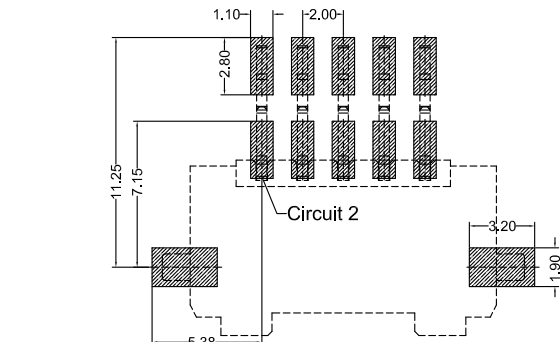
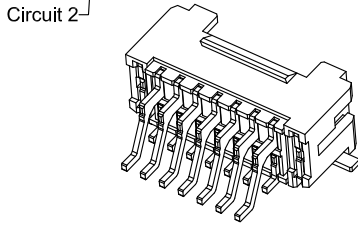
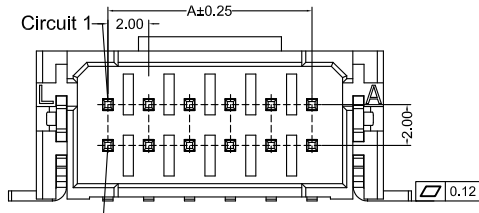
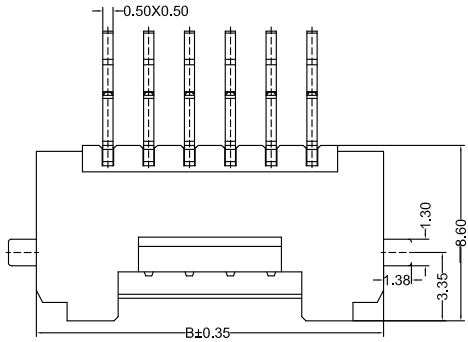

Recommended P.C.B Layout
General Tolerance±0.05

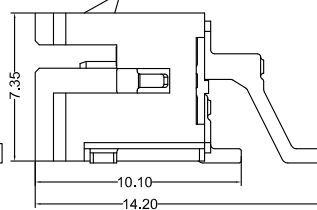

A2023RS 2XX AA P6 TP B A 112
 PIN 205=2X5PINS
 SPECIAL AA=NO Special
 Material LP=LCP 94V-0
 Finish TP=Terminal Tin-Plated
 Code 112
 Color A=Natural
 Packing B=Tape & Reel

CSG PART NO.	Dimension mm		Q'ty/Reel
	A	B	
A2023RS202AALPTPBA112	2.00	9.00	300PCS
A2023RS203AALPTPBA112	4.00	11.00	300PCS
A2023RS204AALPTPBA112	6.00	13.00	300PCS
A2023RS205AALPTPBA112	8.00	15.00	300PCS
A2023RS206AALPTPBA112	10.00	17.00	300PCS
A2023RS207AALPTPBA112	12.00	19.00	300PCS
A2023RS208AALPTPBA112	14.00	21.00	300PCS
A2023RS209AALPTPBA112	16.00	23.00	300PCS
A2023RS210AALPTPBA112	18.00	25.00	300PCS
A2023RS211AALPTPBA112	20.00	27.00	300PCS
A2023RS212AALPTPBA112	22.00	29.00	300PCS
A2023RS213AALPTPBA112	24.00	31.00	300PCS
A2023RS214AALPTPBA112	26.00	33.00	300PCS
A2023RS215AALPTPBA112	28.00	35.00	300PCS
A2023RS216AALPTPBA112	30.00	37.00	300PCS

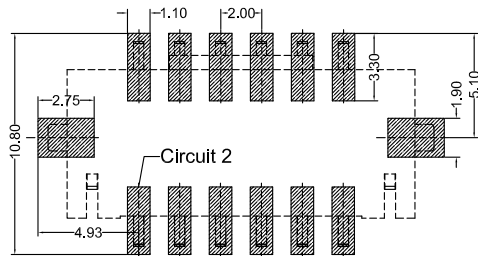
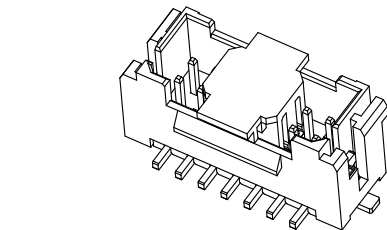
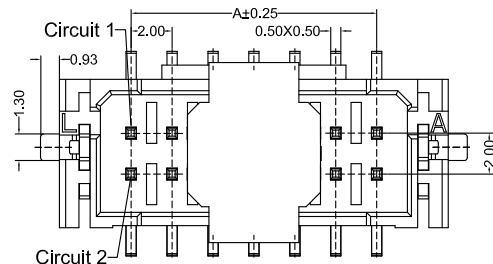
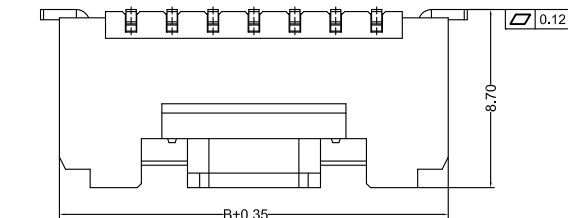

Recommended P.C.B Layout
General Tolerance±0.05

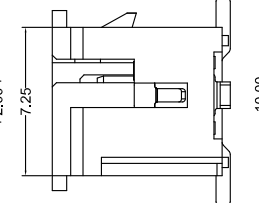

A2023VS 2XX AA P6 TP B A 112
 PIN 205=2X5PINS
 SPECIAL AA=NO Special
 Material LP=LCP 94V-0
 Finish TP=Terminal Tin-Plated
 Code 112
 Color A=Natural
 Packing B=Tape & Reel

CSG PART NO.	Dimension mm		Q'ty/Reel
	A	B	
A2023VS202AALPTPBA112	2.00	9.00	500PCS
A2023VS203AALPTPBA112	4.00	11.00	500PCS
A2023VS204AALPTPBA112	6.00	13.00	500PCS
A2023VS205AALPTPBA112	8.00	15.00	500PCS
A2023VS206AALPTPBA112	10.00	17.00	500PCS
A2023VS207AALPTPBA112	12.00	19.00	500PCS
A2023VS208AALPTPBA112	14.00	21.00	500PCS
A2023VS209AALPTPBA112	16.00	23.00	500PCS
A2023VS210AALPTPBA112	18.00	25.00	500PCS
A2023VS211AALPTPBA112	20.00	27.00	500PCS
A2023VS212AALPTPBA112	22.00	29.00	500PCS
A2023VS213AALPTPBA112	24.00	31.00	500PCS
A2023VS214AALPTPBA112	26.00	33.00	500PCS
A2023VS215AALPTPBA112	28.00	35.00	500PCS
A2023VS216AALPTPBA112	30.00	37.00	500PCS

