

A1253 DF14 CONNECTOR

1.25mm Pitch/Disconnectable Crimp style connectors

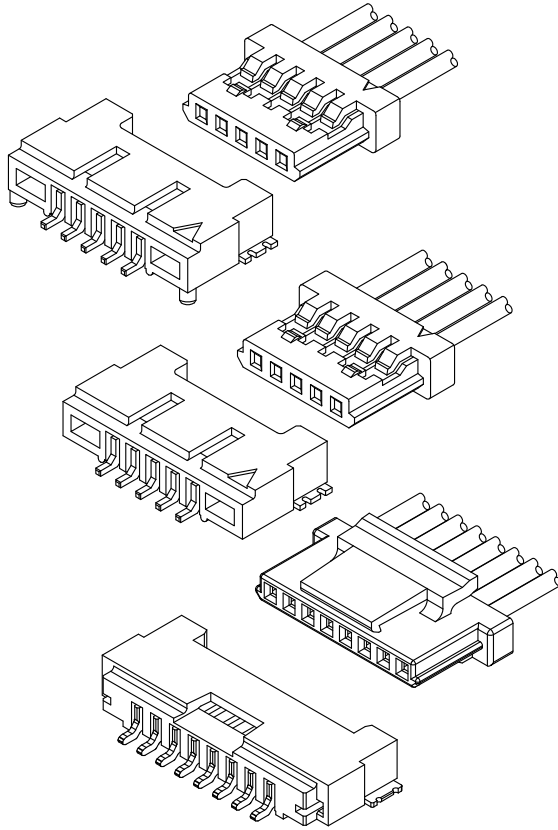

 E529482

Specifications:

- Current rating: 1.0 A / AC,DC
- Voltage rating: 150 V AC/DC
- Temperature range: -25°C ~ +105°C
(including temperature rise in applying electrical current)
- Contact resistance: Initial value/ 30m Ω max
Insulation resistance: 500 M Ω min
Withstanding voltage: 500 VAC/minute
Applicable wire: Conductor size/ AWG#32~#26
Insulation O.D./ 0.32 to 1.10 mm
- * Compliant with RoHS2/ REACH
- * Refer to "General Instruction and Notice when using Terminals and Connectors"
- * Contact CSG for details

Material:

Housing: PA66/UL94-V0;Color: Gray/ Beige/ White
Terminal: Phosphor/ Tin-plated,Gold-Plated
SMT Wafer Housing: PA6T/,UL94-V0;Color:Natural
SMT Wafer Pin: Bass/ Tin-plated/ Gold-Plated
Wafer Fixed Foot: Bass/ Tin-plated

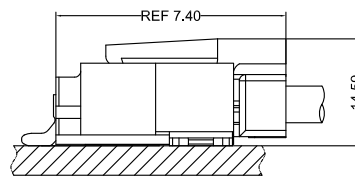
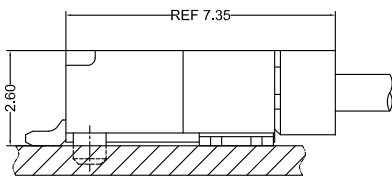

- Note: 1. The above figure is the figure viewed from the connector mounting side.
2. Tolerances are non-cumulative: ±0.08 mm for all centers.
3. The dimensions above should serve as a guideline. Contact CSG for details.

CSG

Tel:+86-769-85312070 85375507 E-mail:James@csg-china.com www.csg-china.com www.jst-connector.cn

A1253 DF14

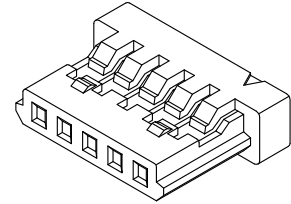
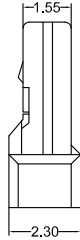
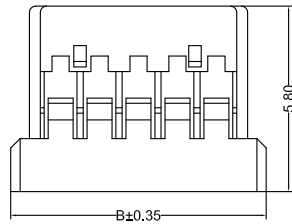
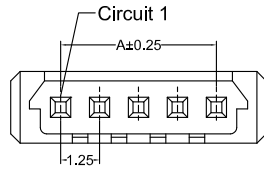

A1253HF 0XX AA P6 X XXX
 PIN
 002=2PINS
 SPECIAL
 AA=NO Special
 Material
 P6=PA66 94V-0
 Code
 188
 110
 008
 Color
 8=Gray
 C=Beige

CSG PART NO.	Dimension mm		Q'ty/BAG
	A	B	
A1253HF002AAP6XXXX	1.25	4.45	1000PCS
A1253HF003AAP6XXXX	2.50	5.70	1000PCS
A1253HF004AAP6XXXX	3.75	6.95	1000PCS
A1253HF005AAP6XXXX	5.00	8.20	1000PCS
A1253HF006AAP6XXXX	6.25	9.45	1000PCS
A1253HF007AAP6XXXX	7.50	10.70	1000PCS
A1253HF008AAP6XXXX	8.75	11.95	1000PCS
A1253HF009AAP6XXXX	10.00	13.20	1000PCS
A1253HF010AAP6XXXX	11.25	14.45	1000PCS
A1253HF011AAP6XXXX	12.50	15.70	1000PCS
A1253HF012AAP6XXXX	13.75	16.95	1000PCS
A1253HF013AAP6XXXX	15.00	18.20	1000PCS
A1253HF014AAP6XXXX	16.25	19.45	1000PCS
A1253HF015AAP6XXXX	17.50	20.70	1000PCS
A1253HF020AAP6XXXX	23.75	26.95	1000PCS
A1253HF025AAP6XXXX	30.00	33.20	1000PCS
A1253HF030AAP6XXXX	36.25	39.45	1000PCS

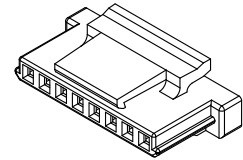
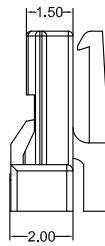
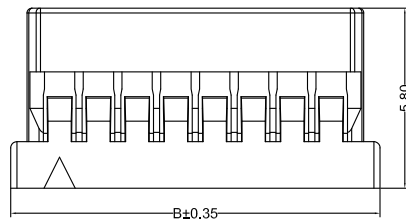
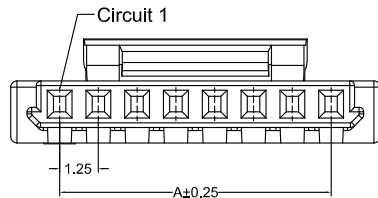

A1253HF 0XX AK P6 X 005
 PIN
 002=2PINS
 SPECIAL
 AK=BUCKLE
 Material
 P6=PA66 94V-0
 Code
 005
 Color
 9=White

CSG PART NO.	Dimension mm		Q'ty/BAG
	A	B	
A1253HF002AKP69005	1.25	4.45	1000PCS
A1253HF003AKP69005	2.50	5.70	1000PCS
A1253HF004AKP69005	3.75	6.95	1000PCS
A1253HF005AKP69005	5.00	8.20	1000PCS
A1253HF006AKP69005	6.25	9.45	1000PCS
A1253HF007AKP69005	7.50	10.70	1000PCS
A1253HF008AKP69005	8.75	11.95	1000PCS
A1253HF009AKP69005	10.00	13.20	1000PCS
A1253HF010AKP69005	11.25	14.45	1000PCS
A1253HF011AKP69005	12.50	15.70	1000PCS
A1253HF012AKP69005	13.75	16.95	1000PCS
A1253HF013AKP69005	15.00	18.20	1000PCS
A1253HF014AKP69005	16.25	19.45	1000PCS
A1253HF015AKP69005	17.50	20.70	1000PCS
A1253HF020AKP69005	23.75	26.95	1000PCS
A1253HF025AKP69005	30.00	33.20	1000PCS
A1253HF030AKP69005	36.25	39.45	1000PCS



A1253 DF14

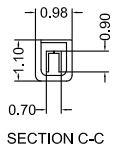
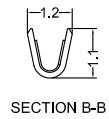
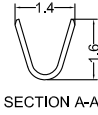
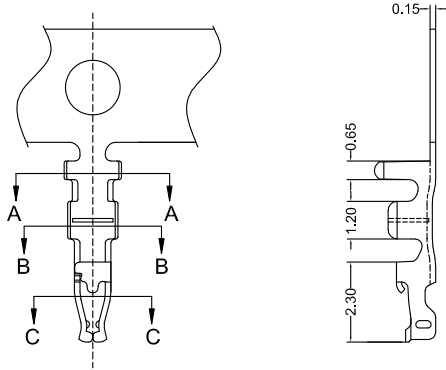

A1253 M 0 A XX 002

- Type M=Female Terminal
- Material A=Phosphor
- Finish TP=Tin-Plated GF=Gold-Plated
- Code 002

CSG PART NO.	Wire Range	Insulation O.D.	Q'ty/Reel
A1253M0ATP002	AWG#26-#32	1.10mm(max)	20000PCS
A1253M0AGF002	AWG#26-#32	1.10mm(max)	20000PCS

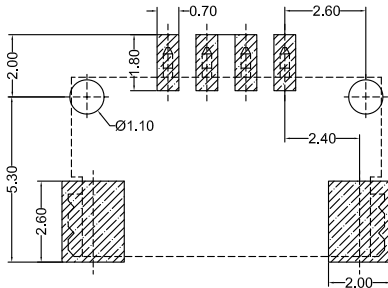
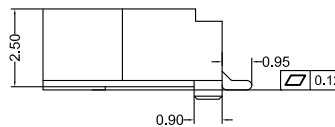
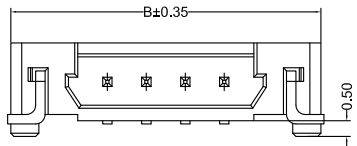
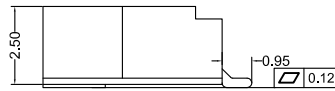
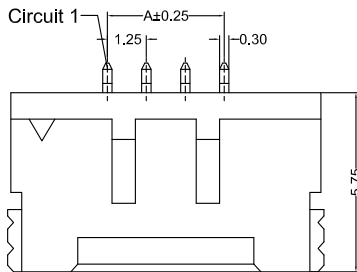

Recommended P.C.B Layout
General Tolerance±0.05

A1253RS 0XX AX 6T XX BA XXX

- PIN 005=5PINS
- SPECIAL AA=Normal AP=Pillars
- Material 6T=PA6T 94V-0
- Finish TP=Terminal Tin-Plated GF=Terminal Gold-Plated
- Code 168 188
- Color A=Natural
- Packing B=Tape & Reel

CSG PART NO.	Dimension mm		Q'ty/Reel
	A	B	
A1253RS002AX6TXXBAXXX	1.25	7.45	1500PCS
A1253RS003AX6TXXBAXXX	2.50	8.70	1500PCS
A1253RS004AX6TXXBAXXX	3.75	9.95	1500PCS
A1253RS005AX6TXXBAXXX	5.00	11.20	1500PCS
A1253RS006AX6TXXBAXXX	6.25	12.45	1500PCS
A1253RS007AX6TXXBAXXX	7.50	13.70	1500PCS
A1253RS008AX6TXXBAXXX	8.75	14.95	1500PCS
A1253RS009AX6TXXBAXXX	10.00	16.20	1500PCS
A1253RS010AX6TXXBAXXX	11.25	17.45	1500PCS
A1253RS011AX6TXXBAXXX	12.50	18.70	1500PCS
A1253RS012AX6TXXBAXXX	13.75	19.95	1500PCS
A1253RS013AX6TXXBAXXX	15.00	21.20	1500PCS
A1253RS014AX6TXXBAXXX	16.25	22.45	1500PCS
A1253RS015AX6TXXBAXXX	17.50	23.70	1500PCS
A1253RS020AX6TXXBAXXX	23.50	29.95	1500PCS
A1253RS025AX6TXXBAXXX	30.00	36.20	1500PCS
A1253RS030AX6TXXBAXXX	36.25	42.45	1500PCS



A1253 DF14

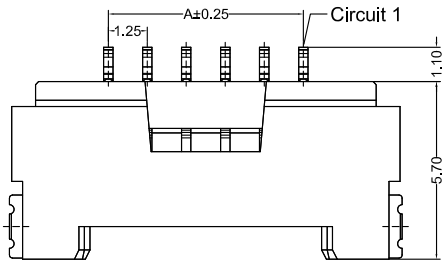

A1253RS_0XX AK 6T IP B A 017

005=5PINS
PIN
SPECIAL
AK=BUCKLE
Material
6T=PA6T 94V-0
Finish
TP=Terminal Tin-Plated

Code
017
Color
A=Natural
Packing
B=Tape & Reel

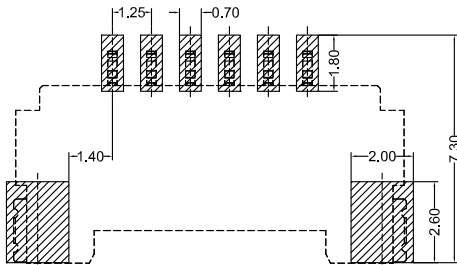
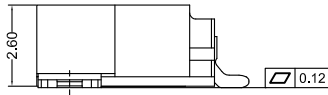
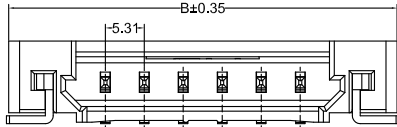
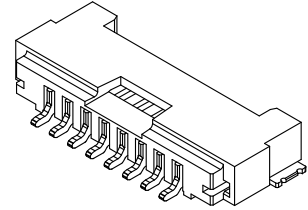

Recommended P.C.B Layout
General Tolerance±0.05

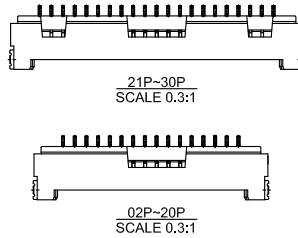

CSG PART NO.	Dimension mm		Q'ty/Reel
	A	B	
A1253RS002AK6TTPBA017	1.25	7.45	1500PCS
A1253RS003AK6TTPBA017	2.50	8.70	1500PCS
A1253RS004AK6TTPBA017	3.75	9.95	1500PCS
A1253RS005AK6TTPBA017	5.00	11.20	1500PCS
A1253RS006AK6TTPBA017	6.25	12.45	1500PCS
A1253RS007AK6TTPBA017	7.50	13.70	1500PCS
A1253RS008AK6TTPBA017	8.75	14.95	1500PCS
A1253RS009AK6TTPBA017	10.00	16.20	1500PCS
A1253RS010AK6TTPBA017	11.25	17.45	1500PCS
A1253RS011AK6TTPBA017	12.50	18.70	1500PCS
A1253RS012AK6TTPBA017	13.75	19.95	1500PCS
A1253RS013AK6TTPBA017	15.00	21.20	1500PCS
A1253RS014AK6TTPBA017	16.25	22.45	1500PCS
A1253RS015AK6TTPBA017	17.50	23.70	1500PCS
A1253RS020AK6TTPBA017	23.50	29.95	1500PCS
A1253RS025AK6TTPBA017	30.00	36.20	1500PCS
A1253RS030AK6TTPBA017	36.25	42.45	1500PCS

